



# ROTOX®

## Pneumatikdokumentation

Pneumatic documentation

Documentation pneumatique

**Projekt:**

SMH-510-4

Maschinennummer	
Zeichnungsnummer	5010000002-0020
Datum	07.08.2020
Beschreibung	Standard

Kunde:	Rotox sp.z.o.o.
Kommission:	Kapica
AB-Nummer	5010000002-0020
Plannummer:	SMH-510-4-64P__5010000002-0020

Maschinentyp:	Standard
Feste Seite:	links
Kämpfertyp:	

Anschlußwert:	6 Bar



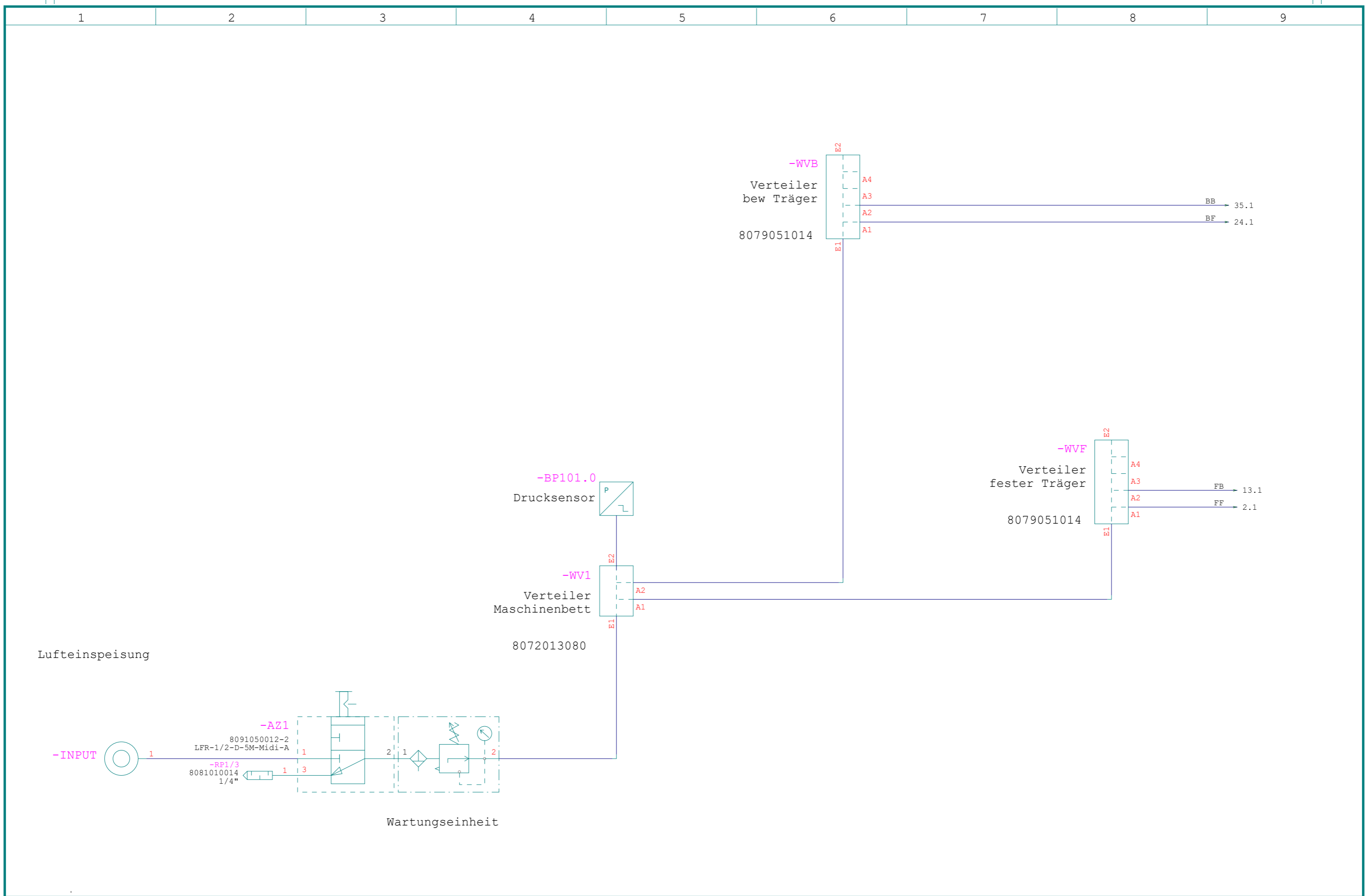

				Datum	07.08.2019	SMH-510-4		SMH-510-4-64P__5010000002-0020		=
				Bearb.	Justus	Rotox sp.z.o.o.				+
				Gepr.						
Zust.	Änderung	Datum	Name	Norm	Urspr.	Ers.f	Ers.d	MNR:	von 45	Blatt 1

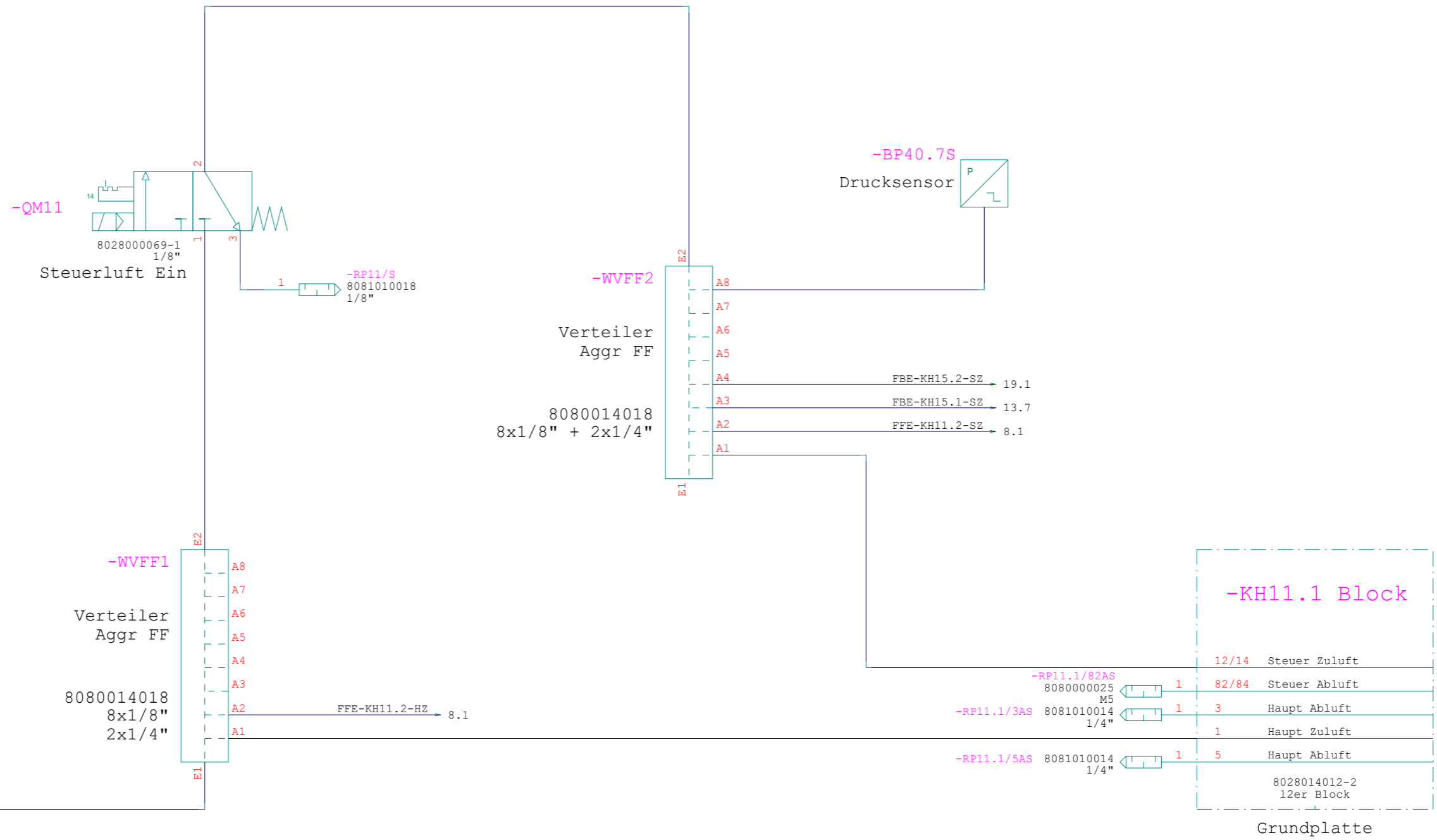

Aggr. FFE KH11.1 Block

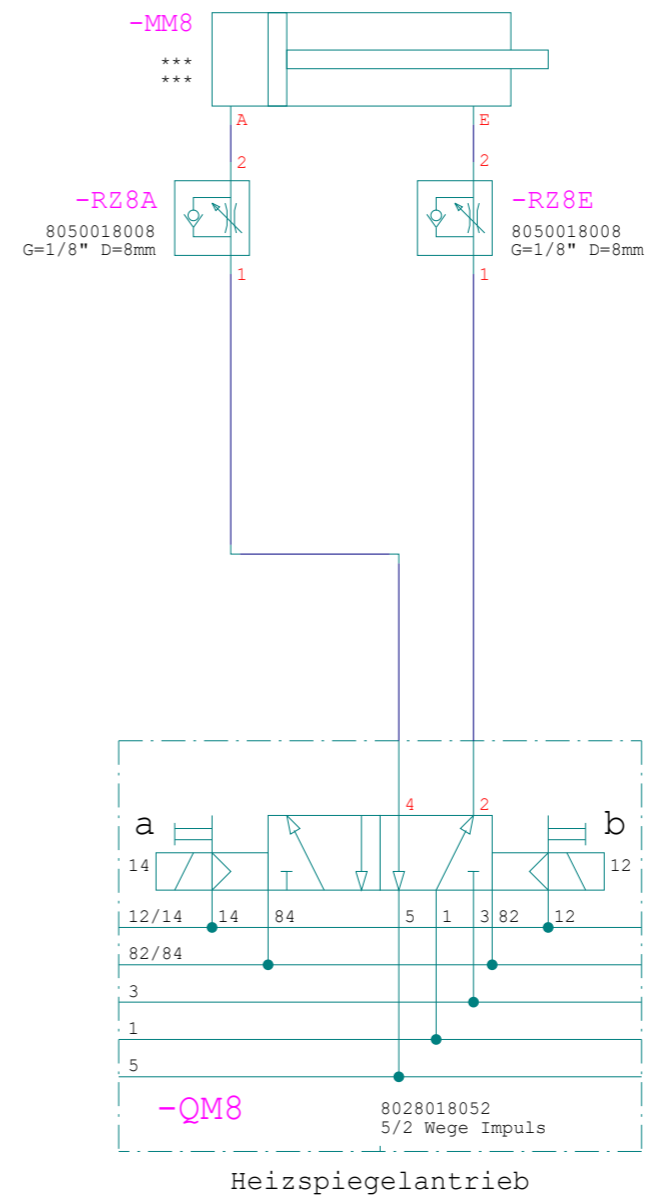
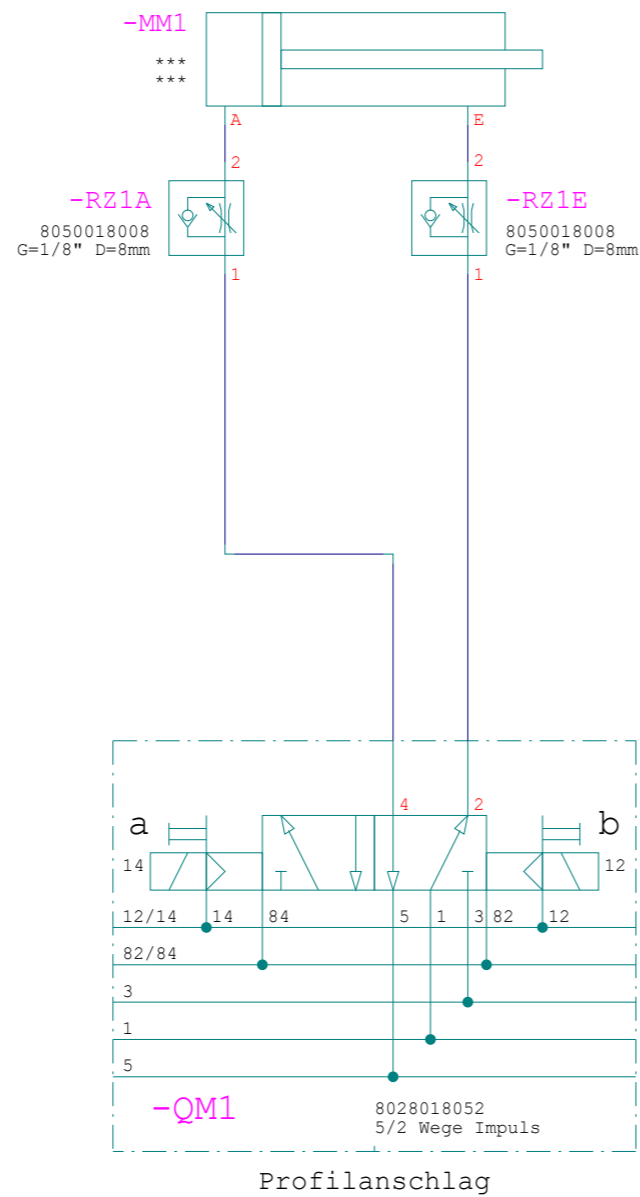

Aggr. FFE KH11.1 Block

		Datum		07.08.2019	SMH-510-4							
		Bearb.		Justus	Rotox sp.z.o.o.				SMH-510-4-64P__5010000002-0020			
		Gepr.										
Zust.	Änderung	Datum	Name	Norm	Urspr.	Ers.f	Ers.d	MNR:		von 45		Blatt 3



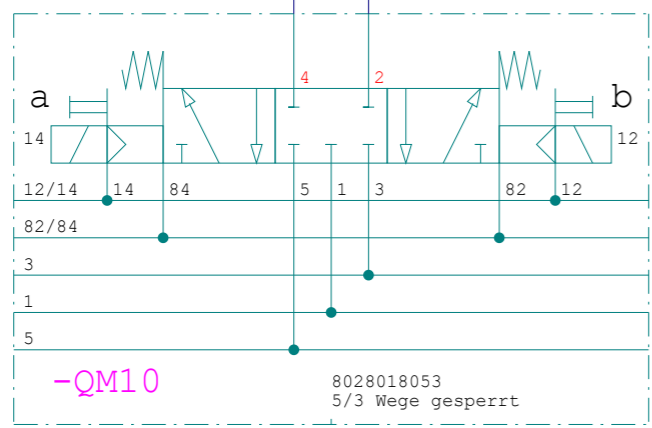
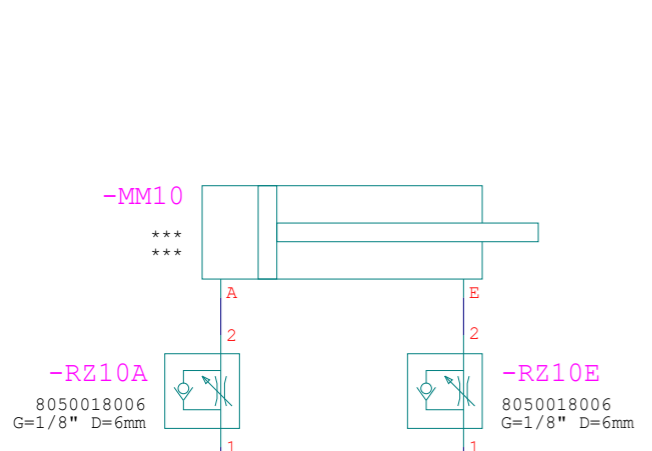

Spannerschiebung Stab BD

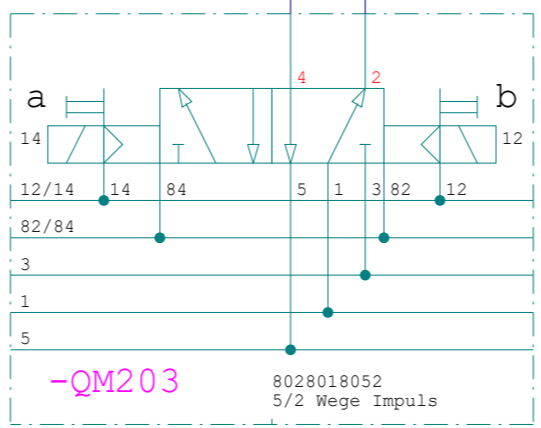
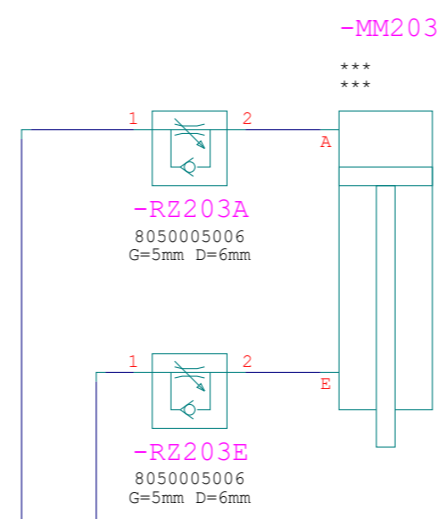

Riegel Kopfverschiebung

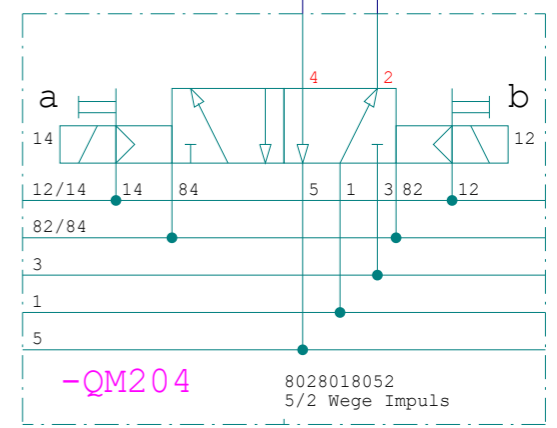
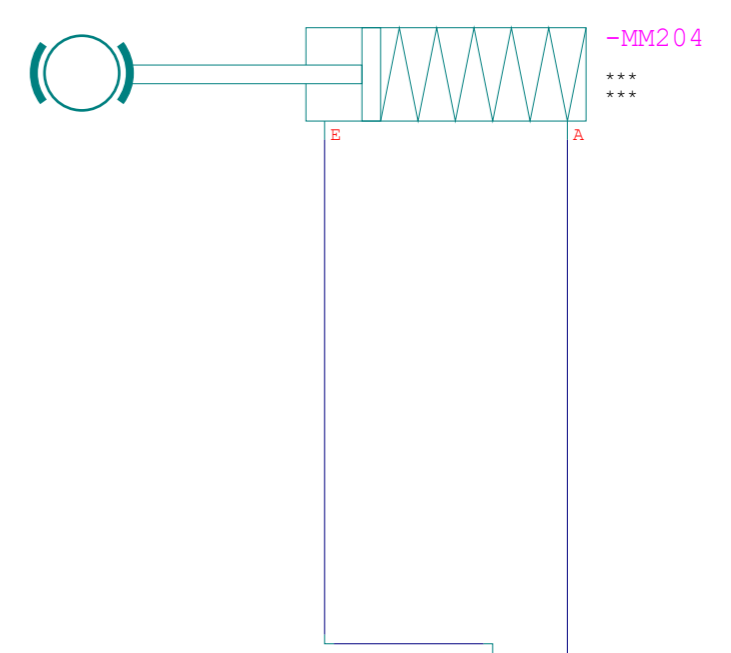

Bremse Kopfverschiebung

Aggr. FFE KH11.1 Block

				Datum	07.08.2019	SMH-510-4 Rotox sp.z.o.o.		SMH-510-4-64P__5010000002-0020		=	
				Bearb.	Justus					+	
				Gepr.							
Zust.	Änderung	Datum	Name	Norm	Urspr.	Ers.f	Ers.d	MNR:		von 45	Blatt 4



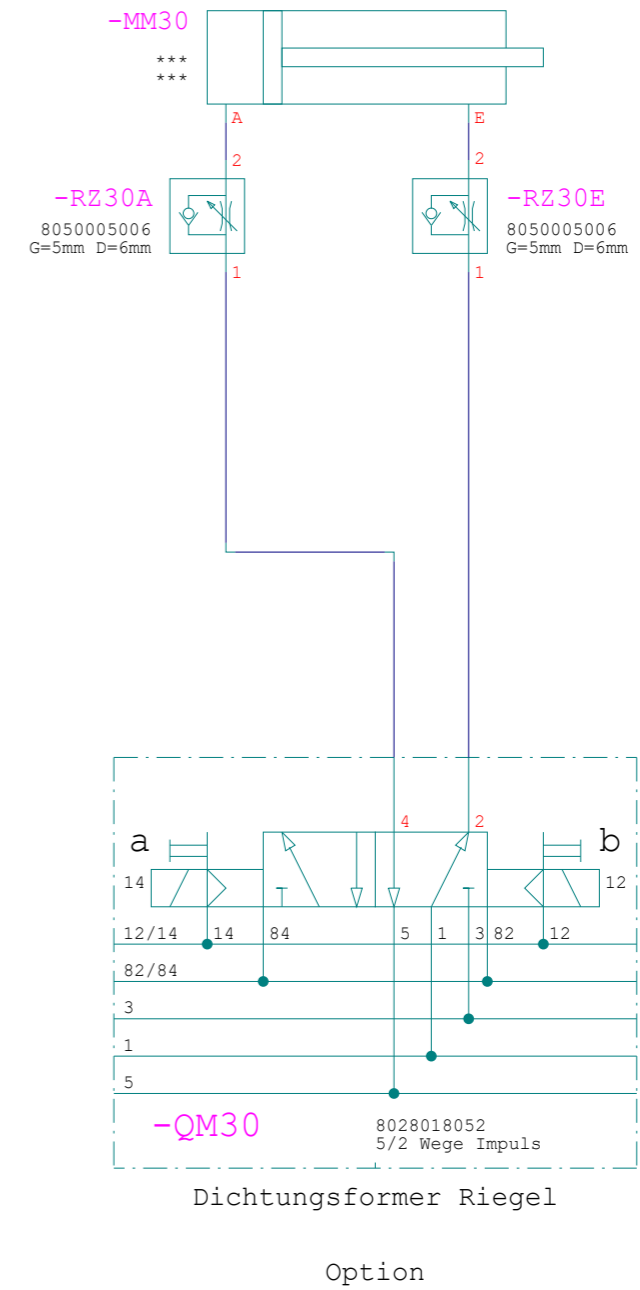
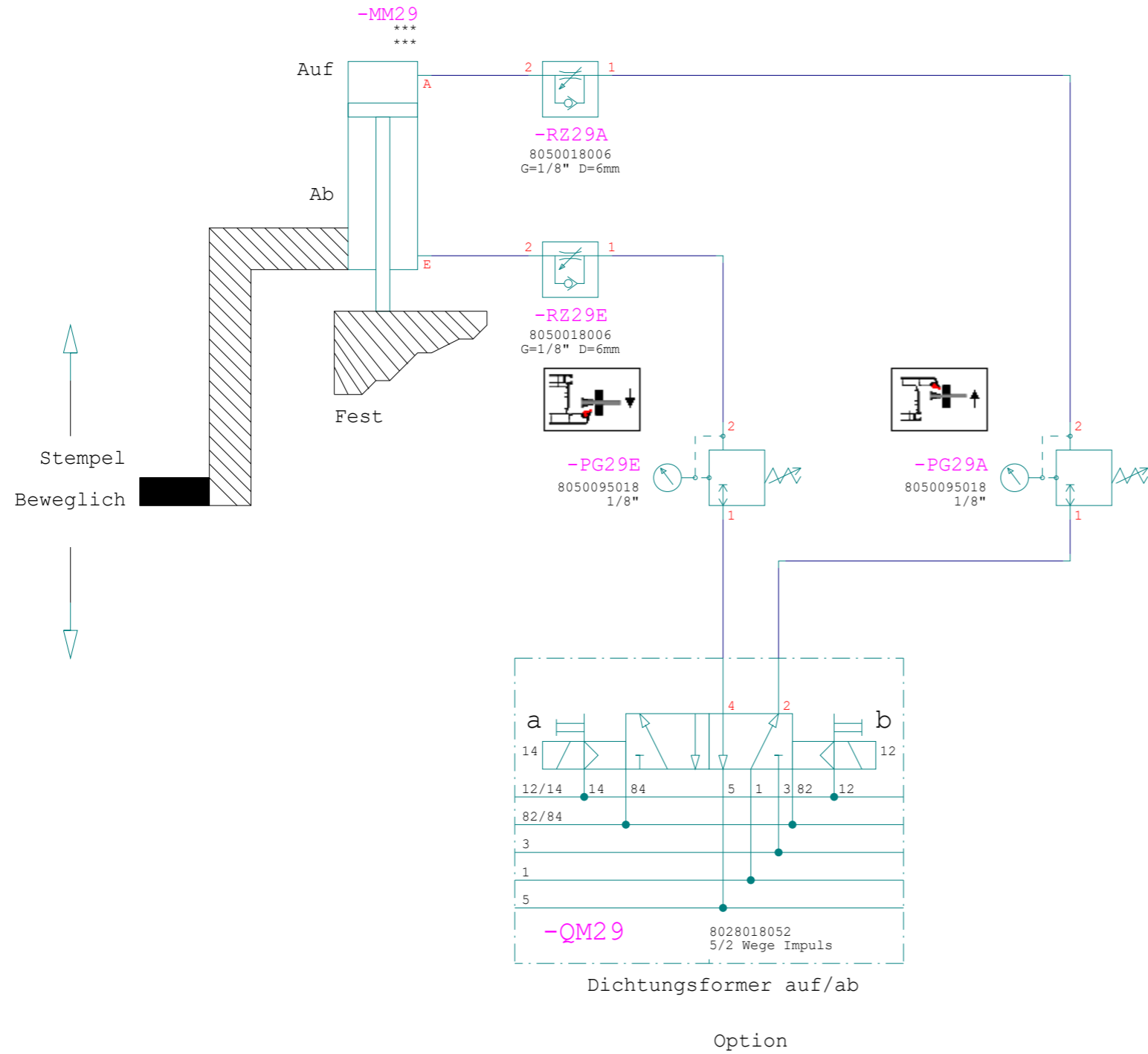

Aggr. FFE KH11.1 Block

				Datum	07.08.2019	SMH-510-4 Rotox sp.z.o.o.		SMH-510-4-64P__5010000002-0020		=	
				Bearb.	Justus					+	
				Gepr.							
Zust.	Änderung	Datum	Name	Norm	Urspr.	Ers.f	Ers.d	MNR:	von 45		Blatt 5





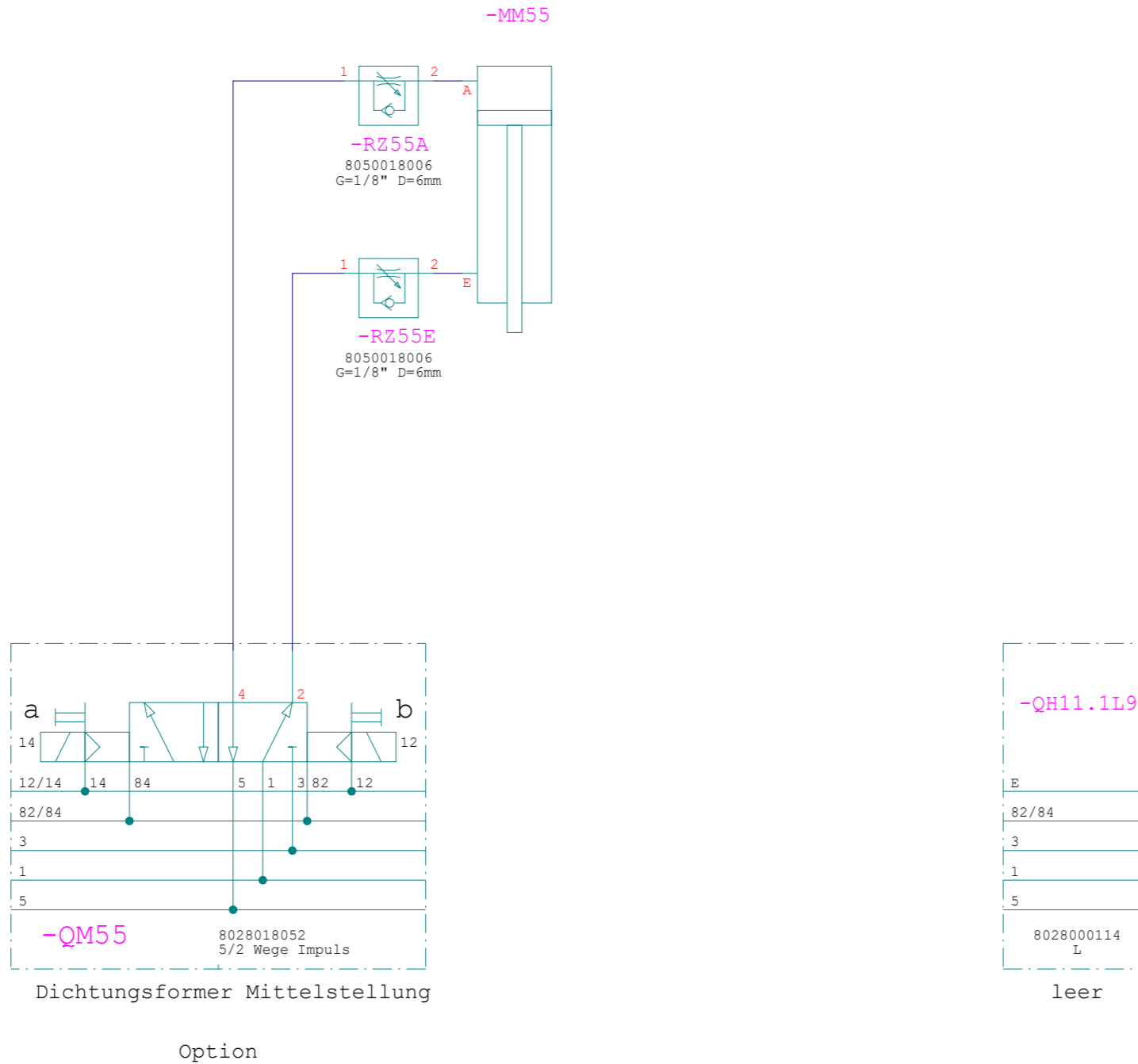

Aggr. FFE KH11.1 Block

				Datum	07.08.2019	SMH-510-4	<b>ROTOX</b> <sup>®</sup>	SMH-510-4-64P__5010000002-0020	=		
				Bearb.	Justus	Rotox sp.z.o.o.			+		
				Gepr.							
Zust.	Änderung	Datum	Name	Norm		Urspr.	Ers.f	Ers.d	MNR:	von 45	Blatt 6



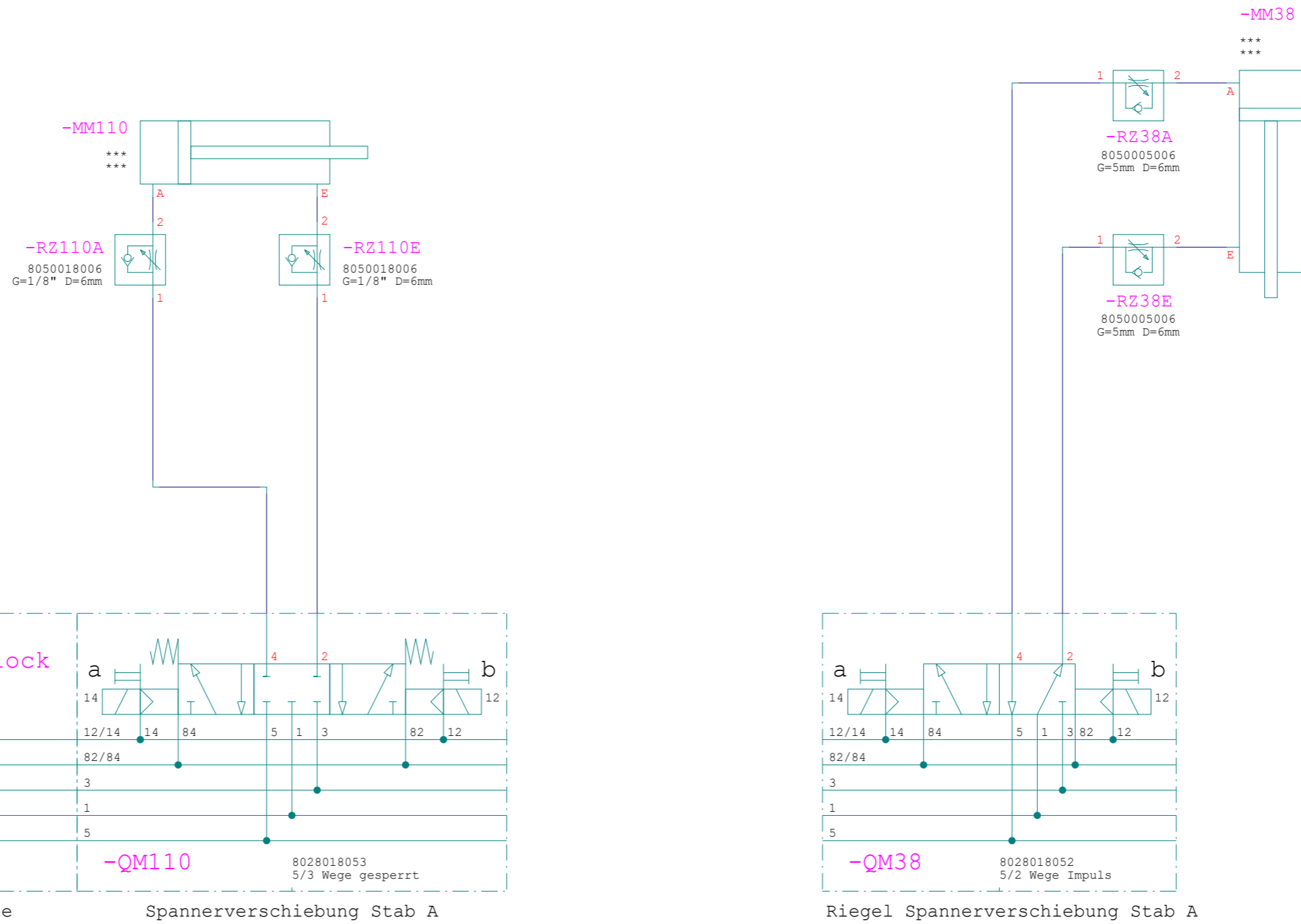

Aggr. FFE KH11.2 Block

				Datum	07.08.2019	SMH-510-4							
				Bearb.	Justus	Rotox sp.z.o.o.		ROTOX®		SMH-510-4-64P__5010000002-0020			
				Gepf.						MNR:		von 45	
Zust.	Änderung	Datum	Name	Norm	Urspr.	Ers.f	Ers.d					Blatt 8	

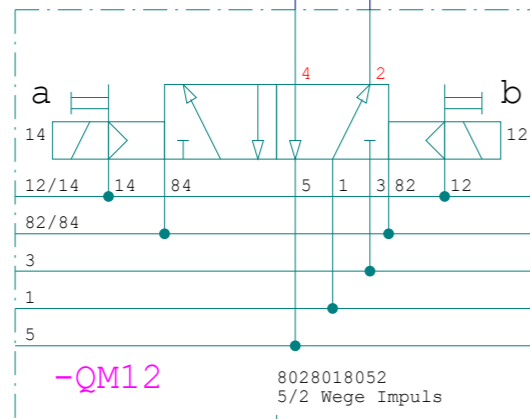
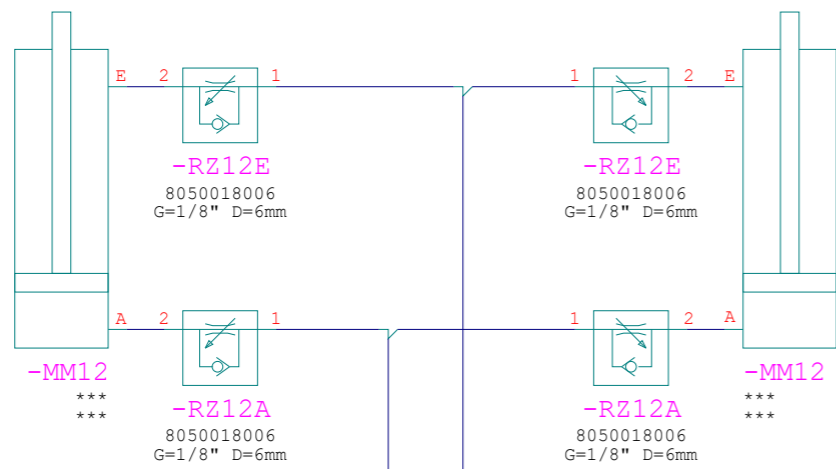

Abtransport Ausheber

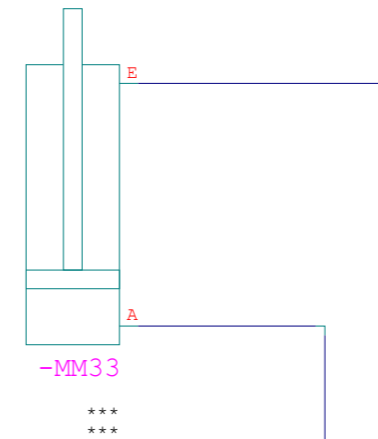

Höheprofil

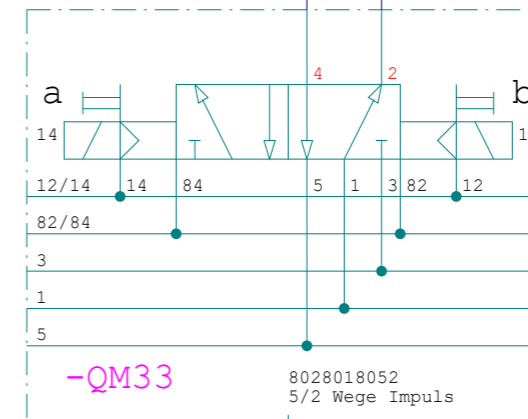

Werkzeuganhebung

Option

Aggr. FFE KH11.2 Block

				Datum	07.08.2019	SMH-510-4							
				Bearb.	Justus	Rotox sp.z.o.o.							
				Gepr.									
Zust.	Änderung	Datum	Name	Norm	Urspr.	Ers.f	Ers.d	SMH-510-4-64P__5010000002-0020		MNR:		=	
												+	
												von 45	Blatt 9



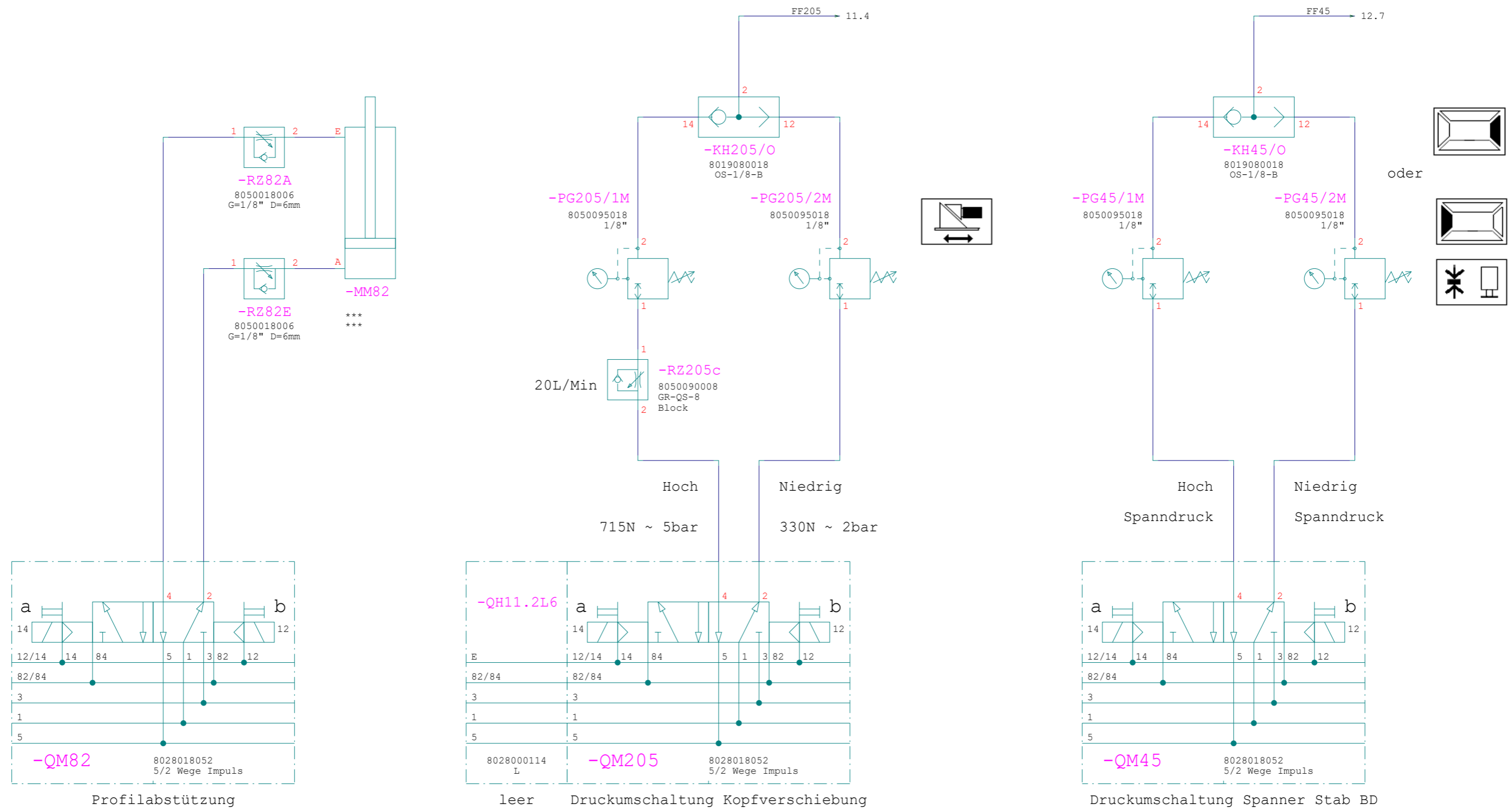

Aggr. FFE KH11.2 Block

Datum		07.08.2019		SMH-510-4		=	
Bearb.		Justus		Rotox sp.z.o.o.		+	
Gepr.							
Zust.	Änderung	Datum	Name	Norm	Urspr.	Ers.f	Ers.d
						MNR:	
						von 45	
						Blatt 10	



SMH-510-4-64P\_\_5010000002-0020

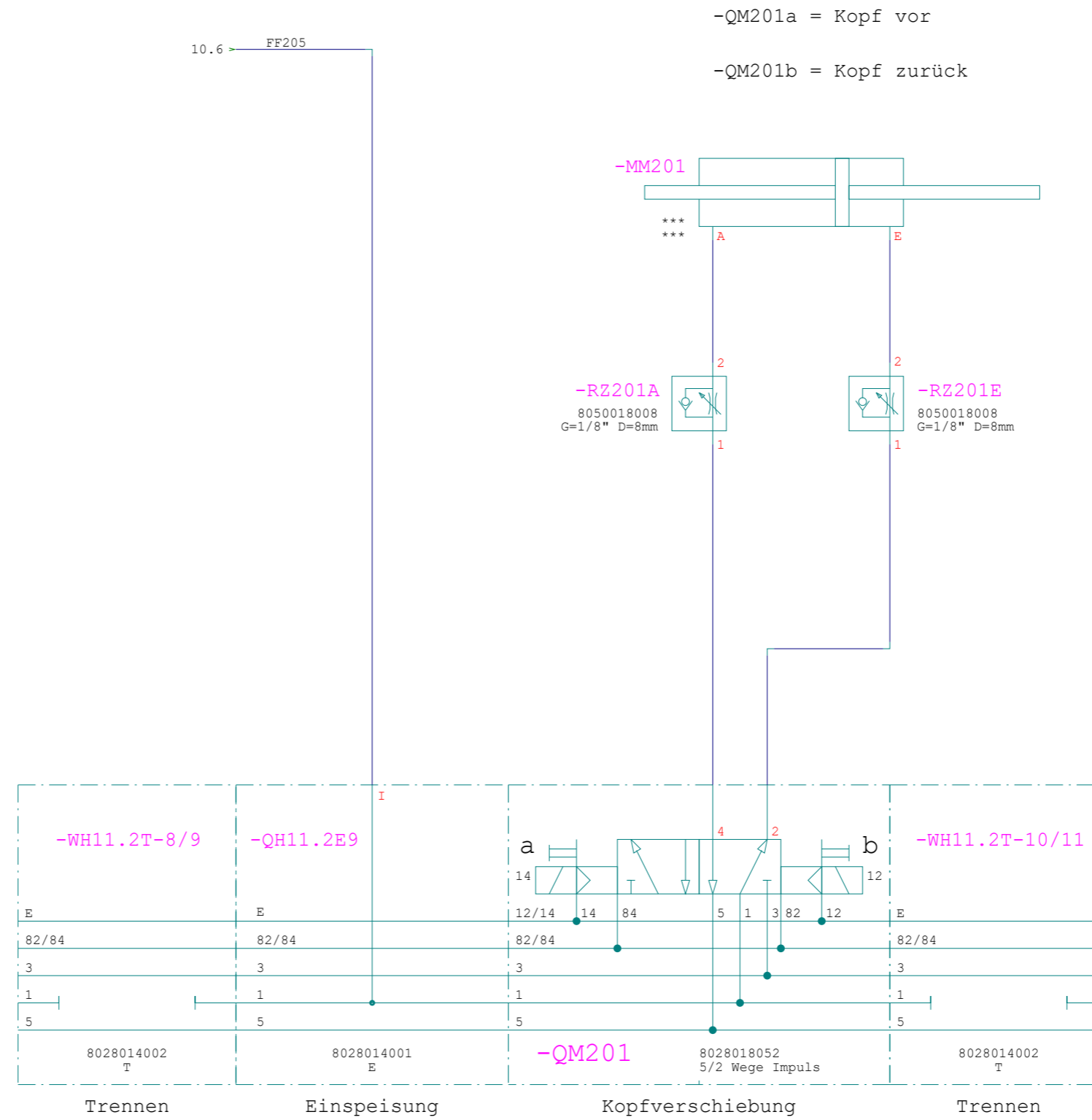

Aggr. FFE KH11.2 Block

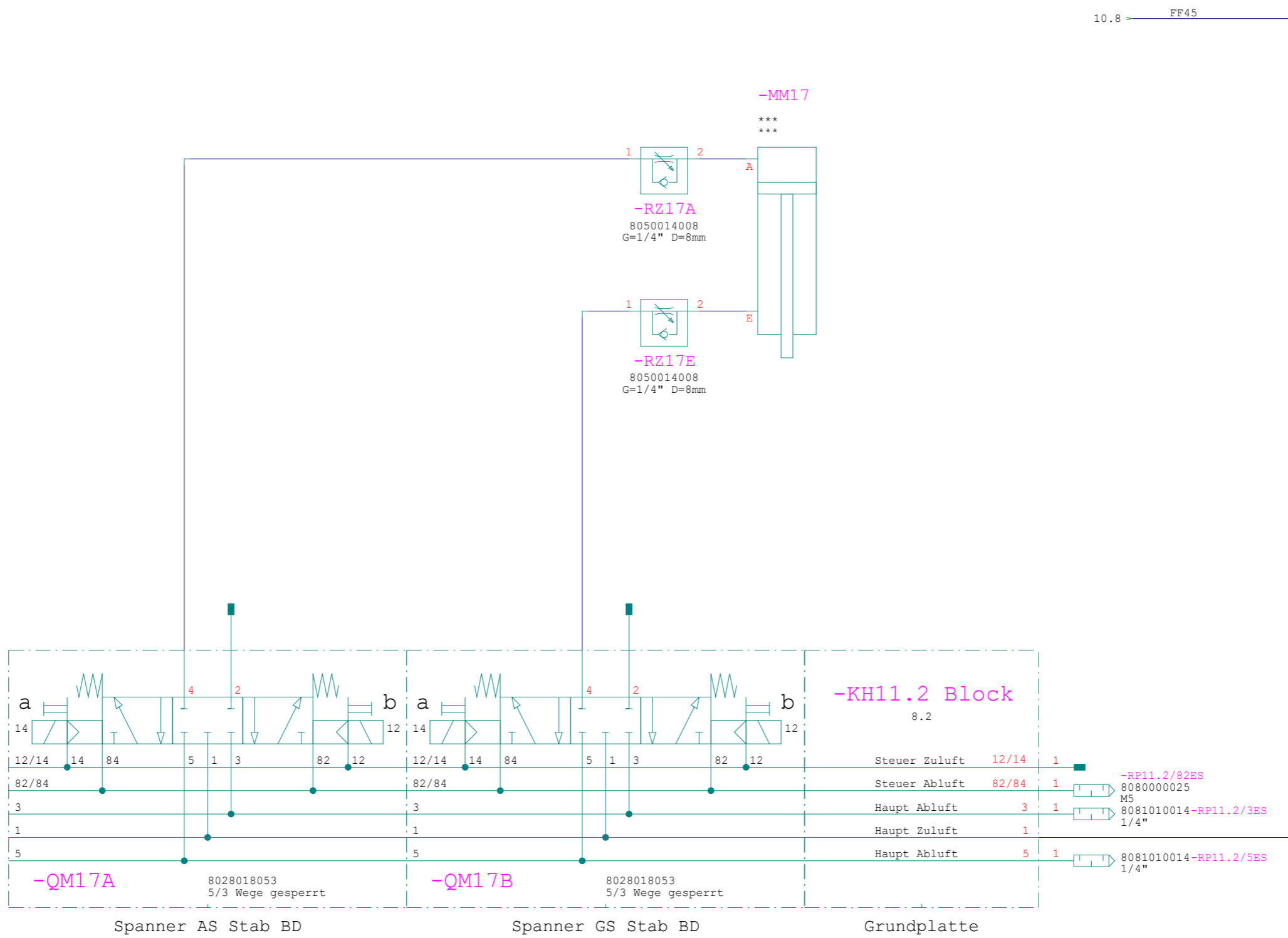

Datum		07.08.2019		SMH-510-4		<b>ROTOX</b>		SMH-510-4-64P__5010000002-0020		=	
Bearb.		Justus		Rotox sp.z.o.o.						+	
Gepr.				Urspr.		Ers.f		Ers.d		MNR:	
Zust.	Änderung	Datum	Name	Norm						von 45	Blatt 12



Aggr. FBE KH15.1 Block

				Datum	07.08.2019	SMH-510-4							
				Bearb.	Justus	Rotox sp.z.o.o.							
				Gepr.									
Zust.	Änderung	Datum	Name	Norm	Urspr.	Ers.f	Ers.d	SMH-510-4-64P__5010000002-0020		MNR:		von 45	Blatt 13





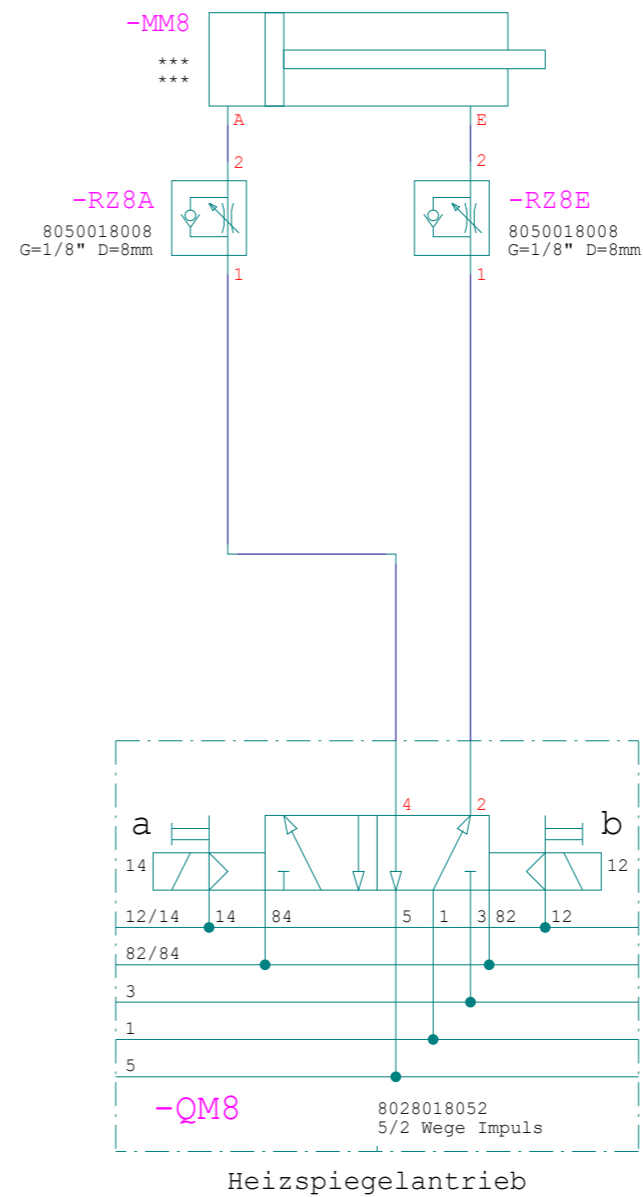
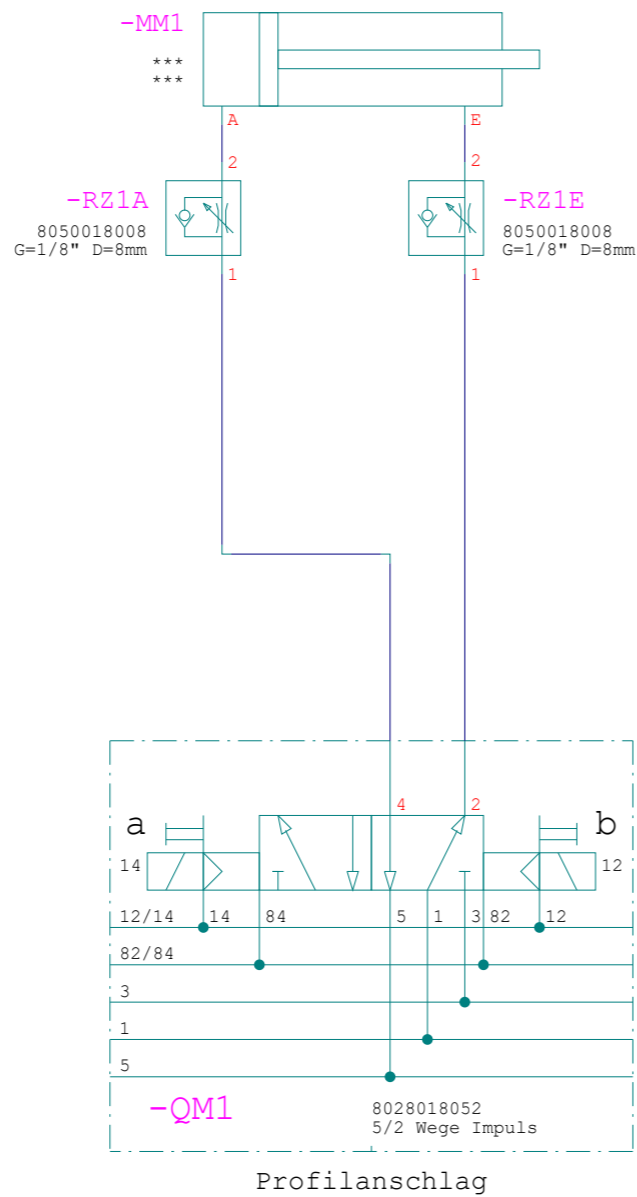

Aggr. FBE KH15.1 Block

				Datum	07.08.2019	SMH-510-4							
				Bearb.	Justus	Rotox sp.z.o.o.		ROTOX®		SMH-510-4-64P__5010000002-0020			
				Gepr.									
Zust.	Änderung	Datum	Name	Norm	Urspr.	Ers.f	Ers.d	MNR:		von 45		Blatt 14	

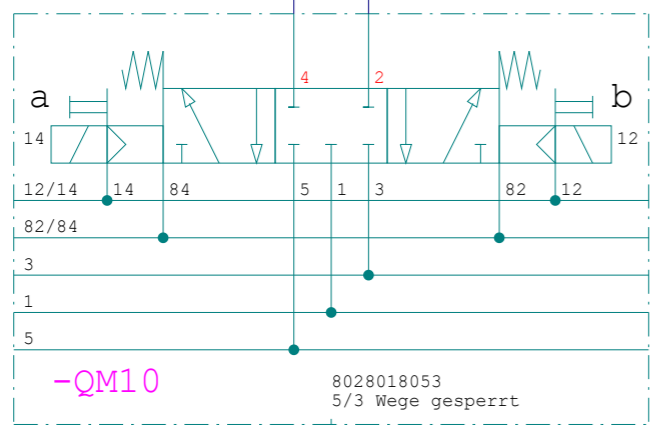
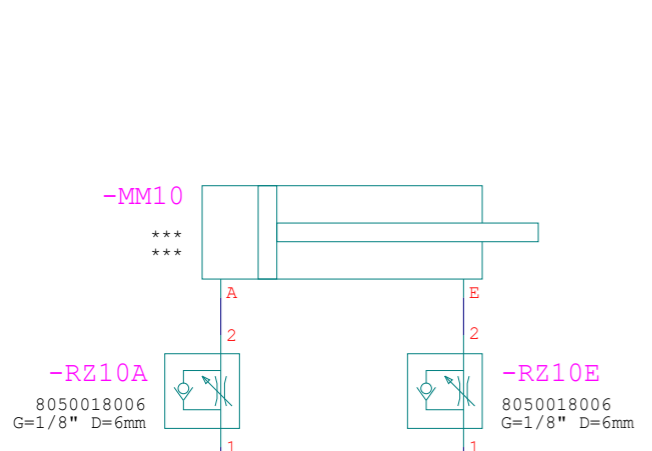

Spannerschiebung Stab BD

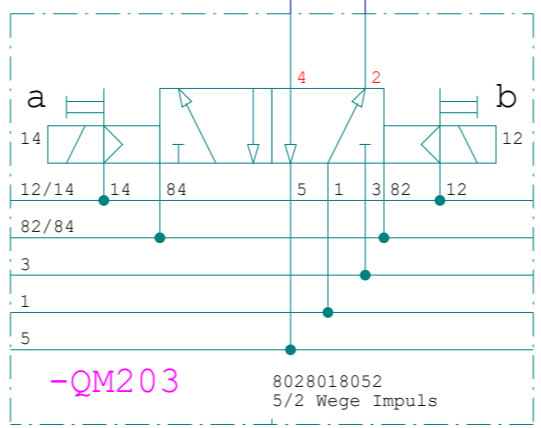
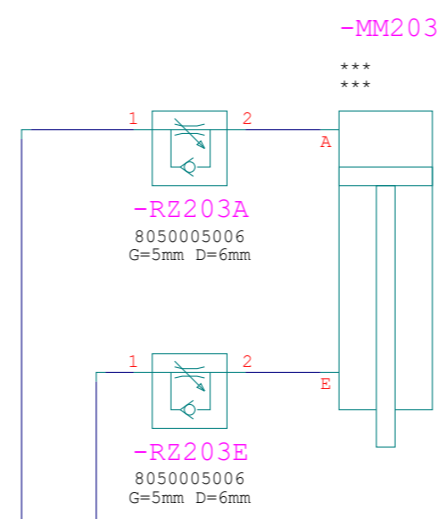

Riegel Kopfverschiebung

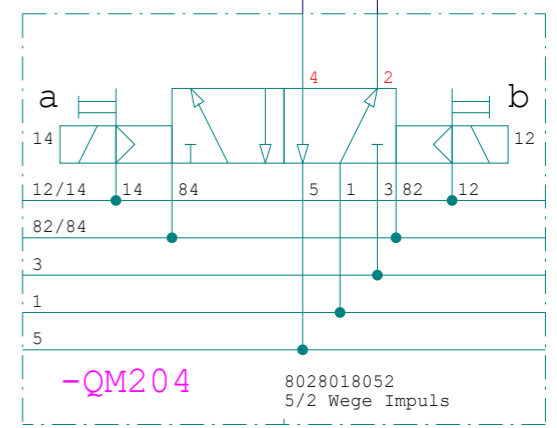
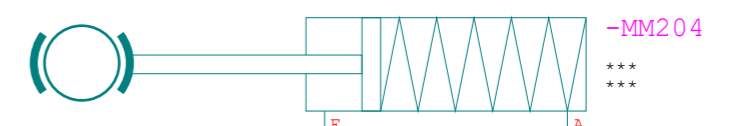

Bremse Kopfverschiebung

Aggr. FBE KH15.1 Block



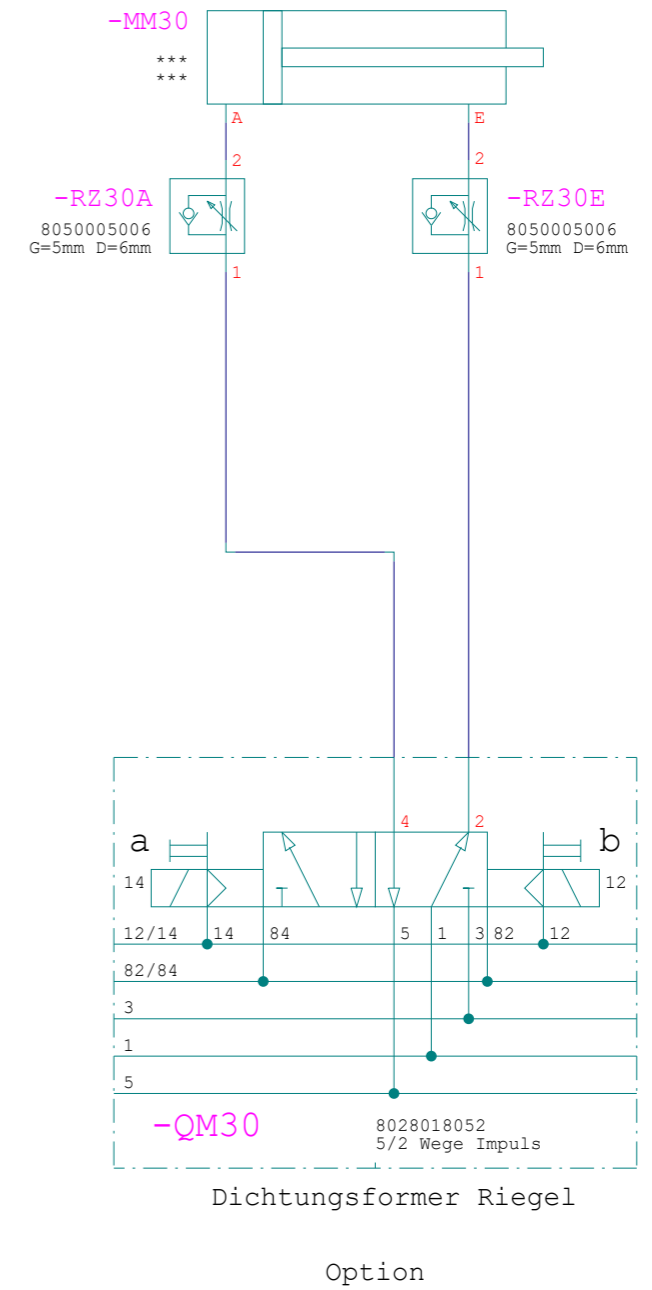
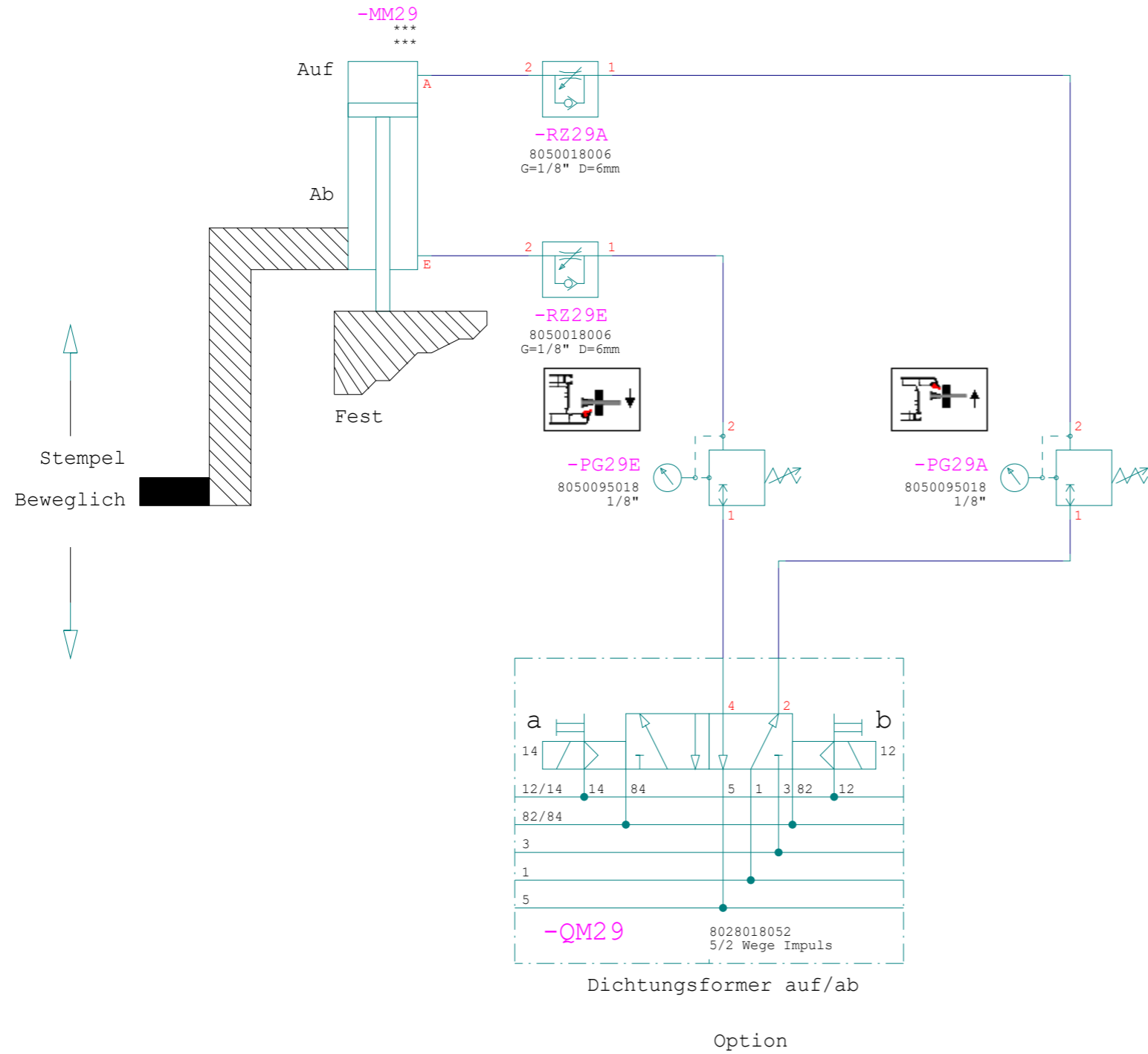

Aggr. FBE KH15.1 Block

		Datum	07.08.2019	SMH-510-4 Rotox sp.z.o.o.		<b>ROTOX</b>		SMH-510-4-64P__5010000002-0020		=	
		Bearb.	Justus							+	
Zust.	Änderung	Datum	Name	Norm	Urspr.	Ers.f	Ers.d	MNR:		von 45	
										Blatt 16	

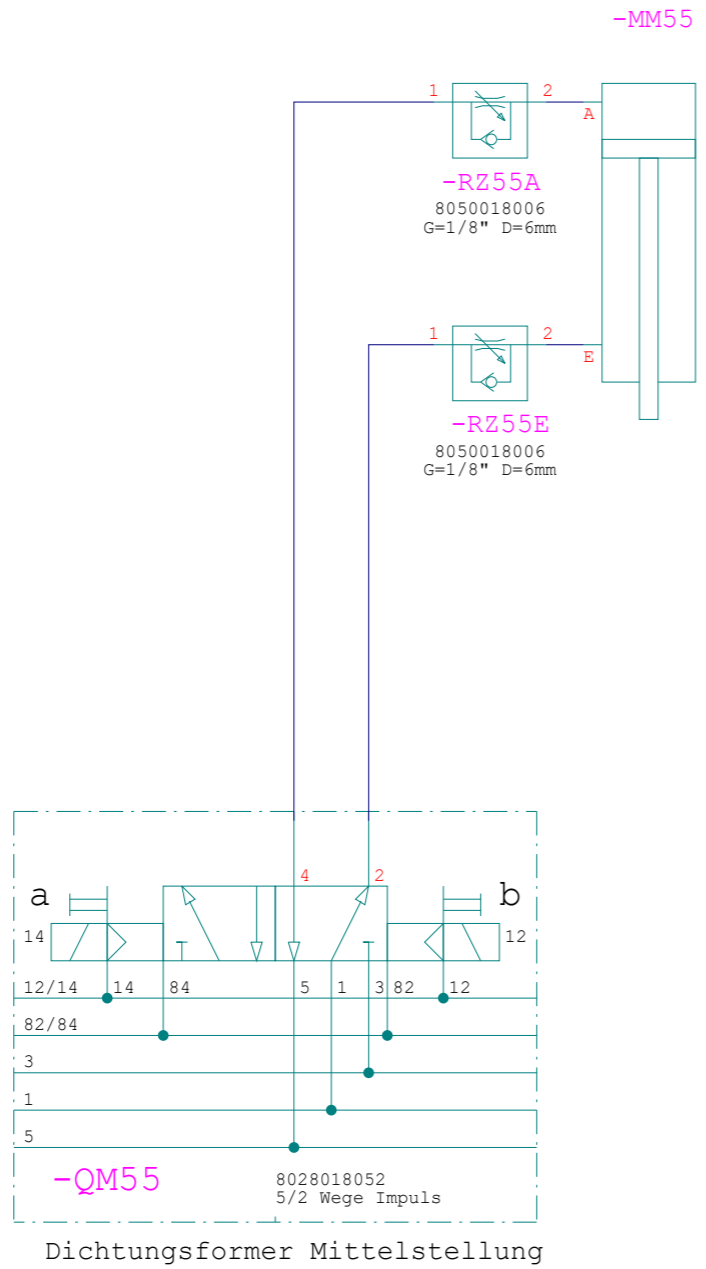

Option

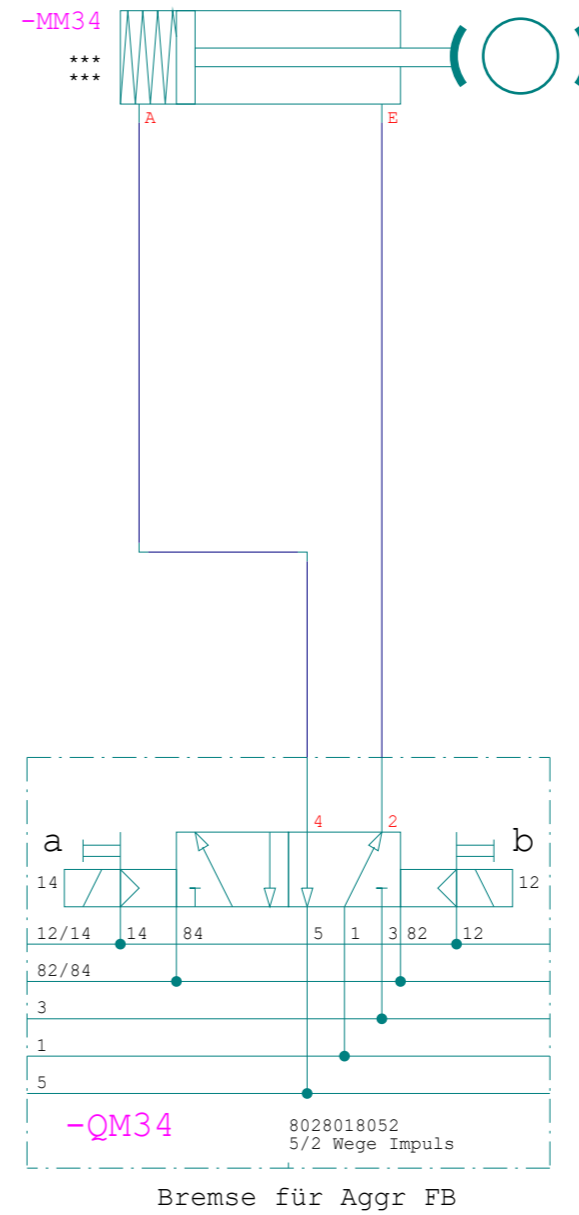

Aggr. FBE KH15.1 Block

				Datum	07.08.2019	SMH-510-4 Rotox sp.z.o.o.		SMH-510-4-64P__5010000002-0020		=	
				Bearb.	Justus					+	
				Gepr.							
Zust.	Änderung	Datum	Name	Norm	Urspr.	Ers.f	Ers.d	MNR:		von 45	Blatt 17

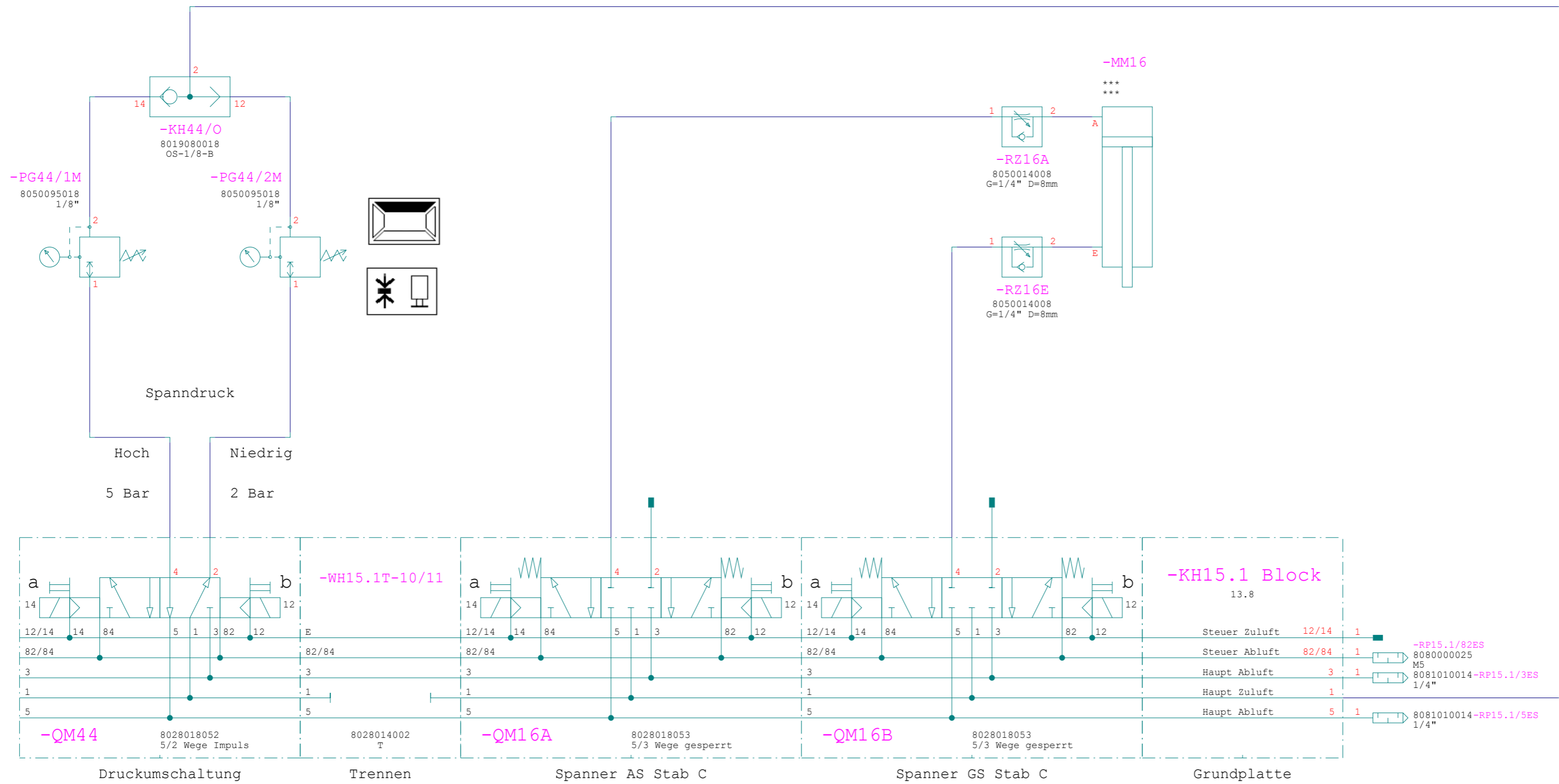

Aggr. FBE KH15.1 Block

		Datum	07.08.2019	SMH-510-4 Rotox sp.z.o.o.		SMH-510-4-64P__5010000002-0020		=	
		Bearb.	Justus					+	
		Gepr.							
Zust.	Änderung	Datum	Name	Norm	Urspr.	Ers.f	Ers.d	MNR:	von 45    Blatt 18

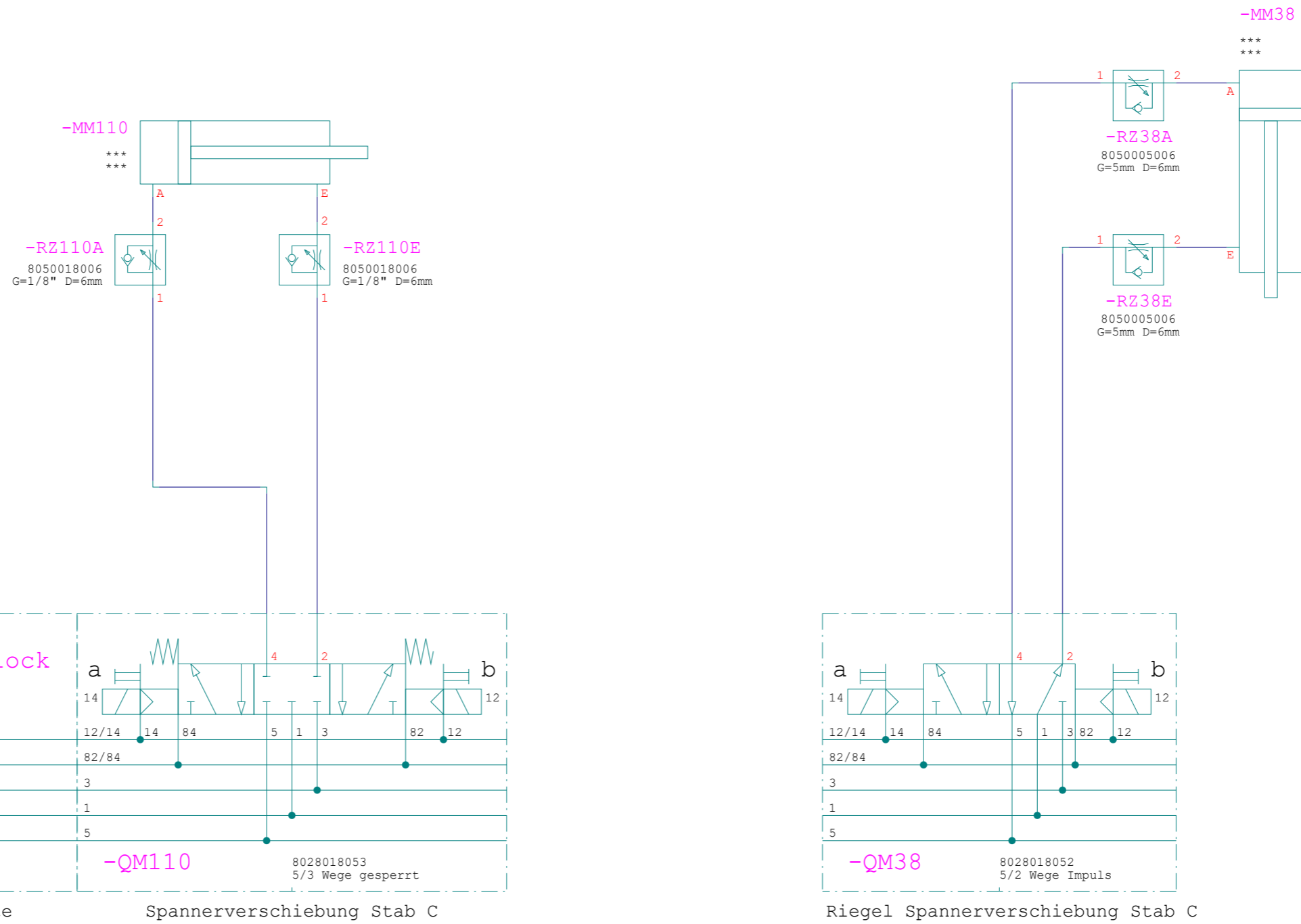

Aggr. FBE KH15.2 Block

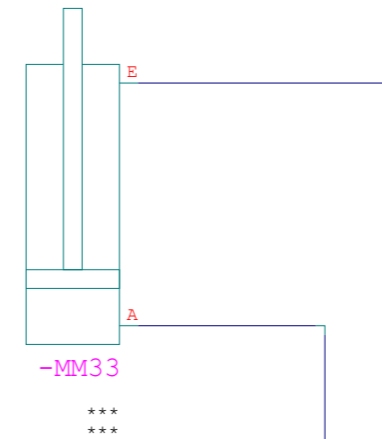

Höheprofil

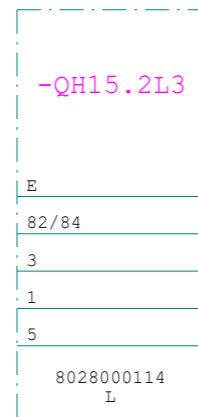

leer

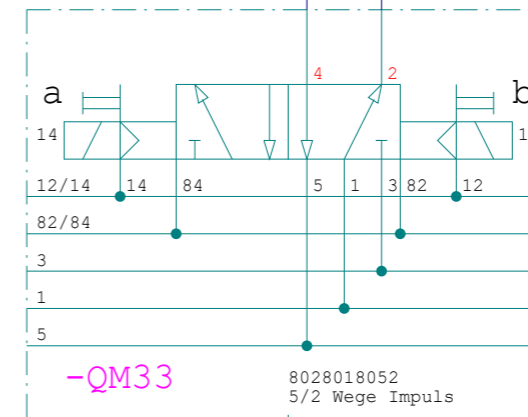

Werkzeuganhebung

Option

Aggr. FBE KH15.2 Block

				Datum	07.08.2019	SMH-510-4							
				Bearb.	Justus	Rotox sp.z.o.o.							
				Gepr.									
Zust.	Änderung	Datum	Name	Norm		Urspr.	Ers.f	Ers.d		MNR:		von 45	Blatt 20



SMH-510-4-64P\_\_5010000002-0020

=  
+

MNR:

von 45

Blatt 20

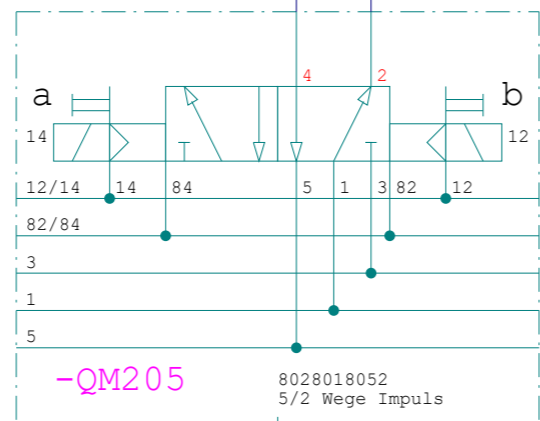
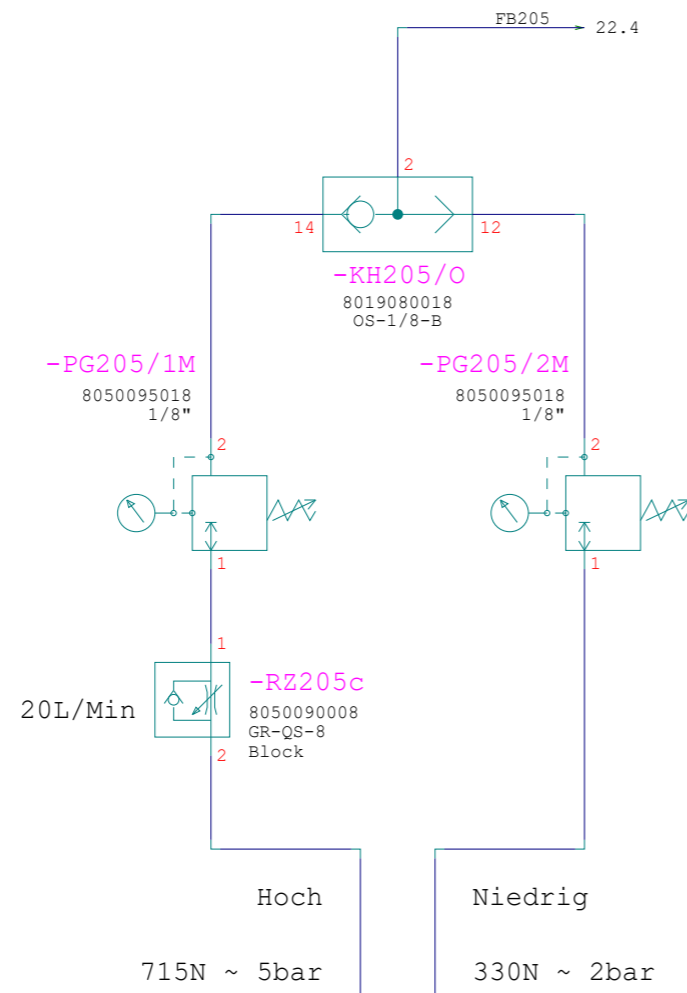

Druckumschaltung Kopfverschiebung

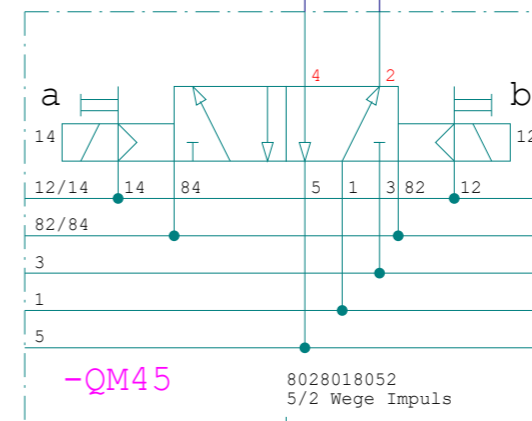
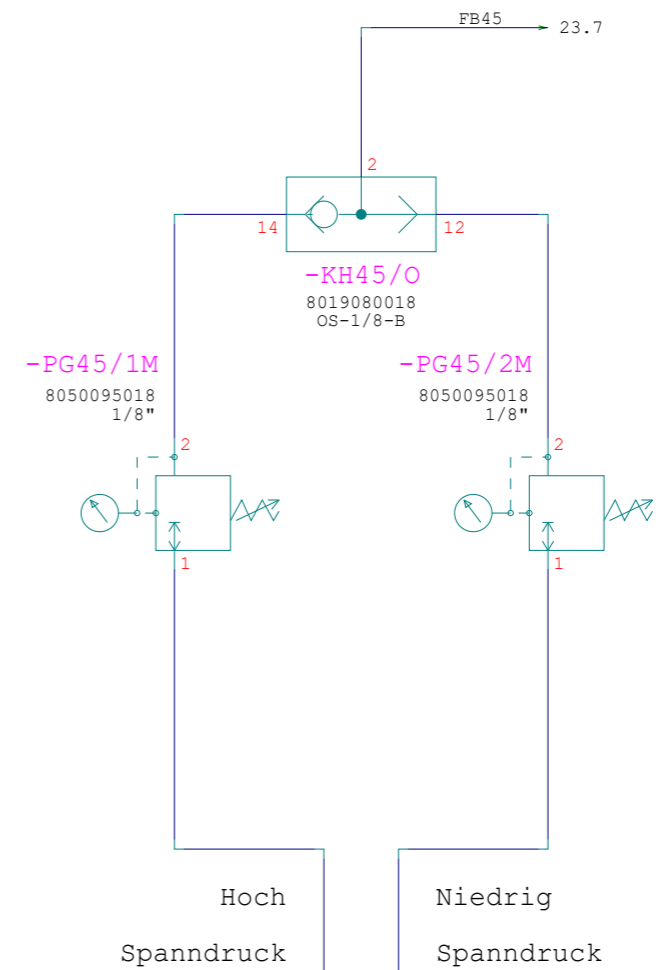

Druckumschaltung Spanner Stab BD

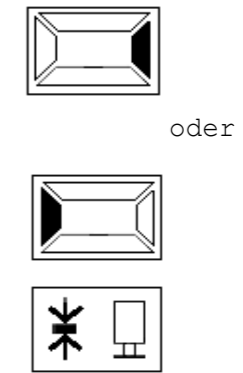

Aggr. FBE KH15.2 Block

				Datum	07.08.2019	SMH-510-4		<b>ROTOX</b>	SMH-510-4-64P__5010000002-0020		=
				Bearb.	Justus	Rotox sp.z.o.o.					+
				Gepr.							
Zust.	Änderung	Datum	Name	Norm	Urspr.	Ers.f	Ers.d	MNR:		von 45	Blatt 21



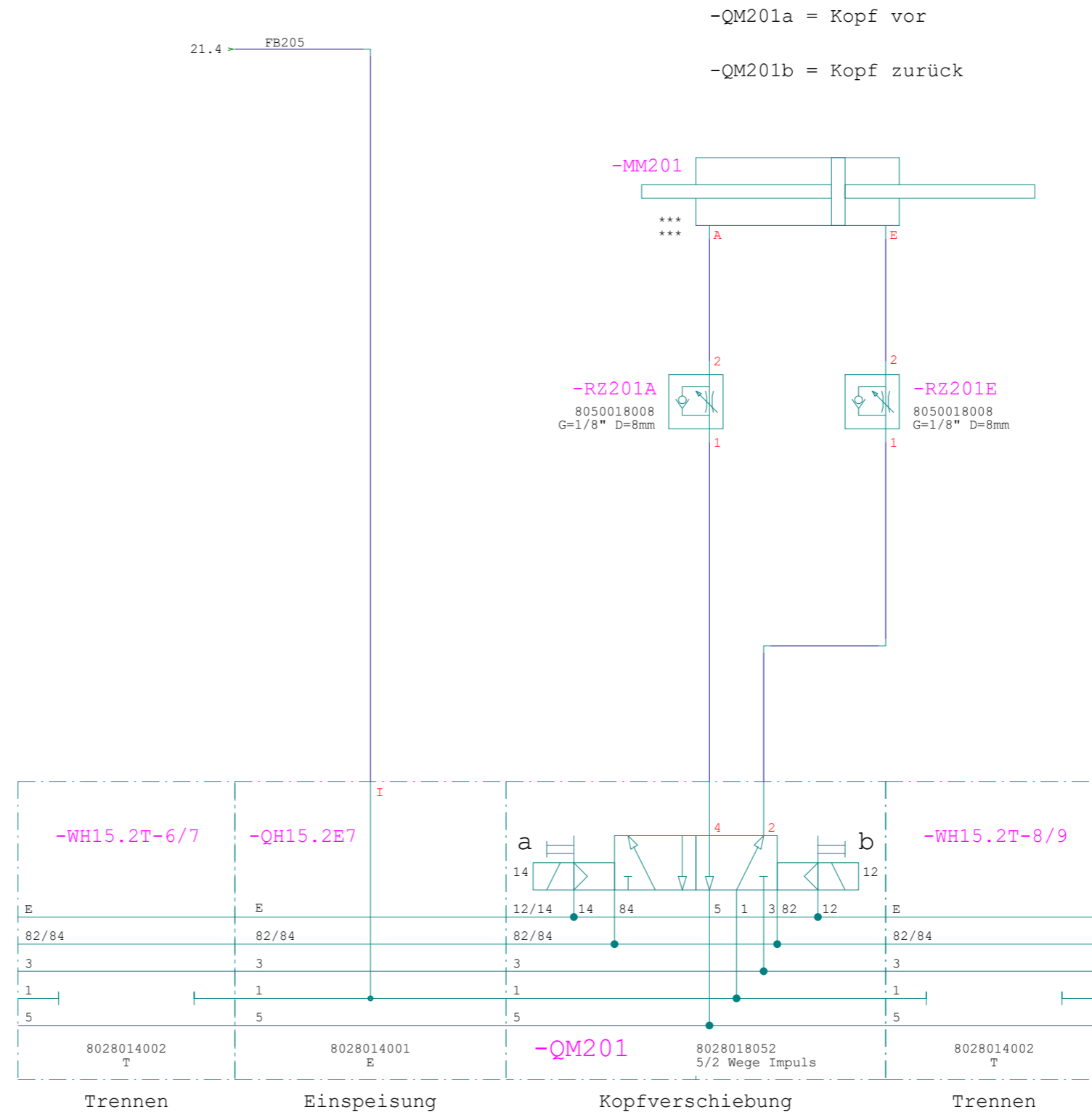

				Datum	07.08.2019	SMH-510-4 Rotox sp.z.o.o.	<b>ROTOX</b>	SMH-510-4-64P__5010000002-0020	=		
				Bearb.	Justus				+		
				Gepr.							
Zust.	Änderung	Datum	Name	Norm		Urspr.	Ers.f	Ers.d	MNR:	von 45	Blatt 22

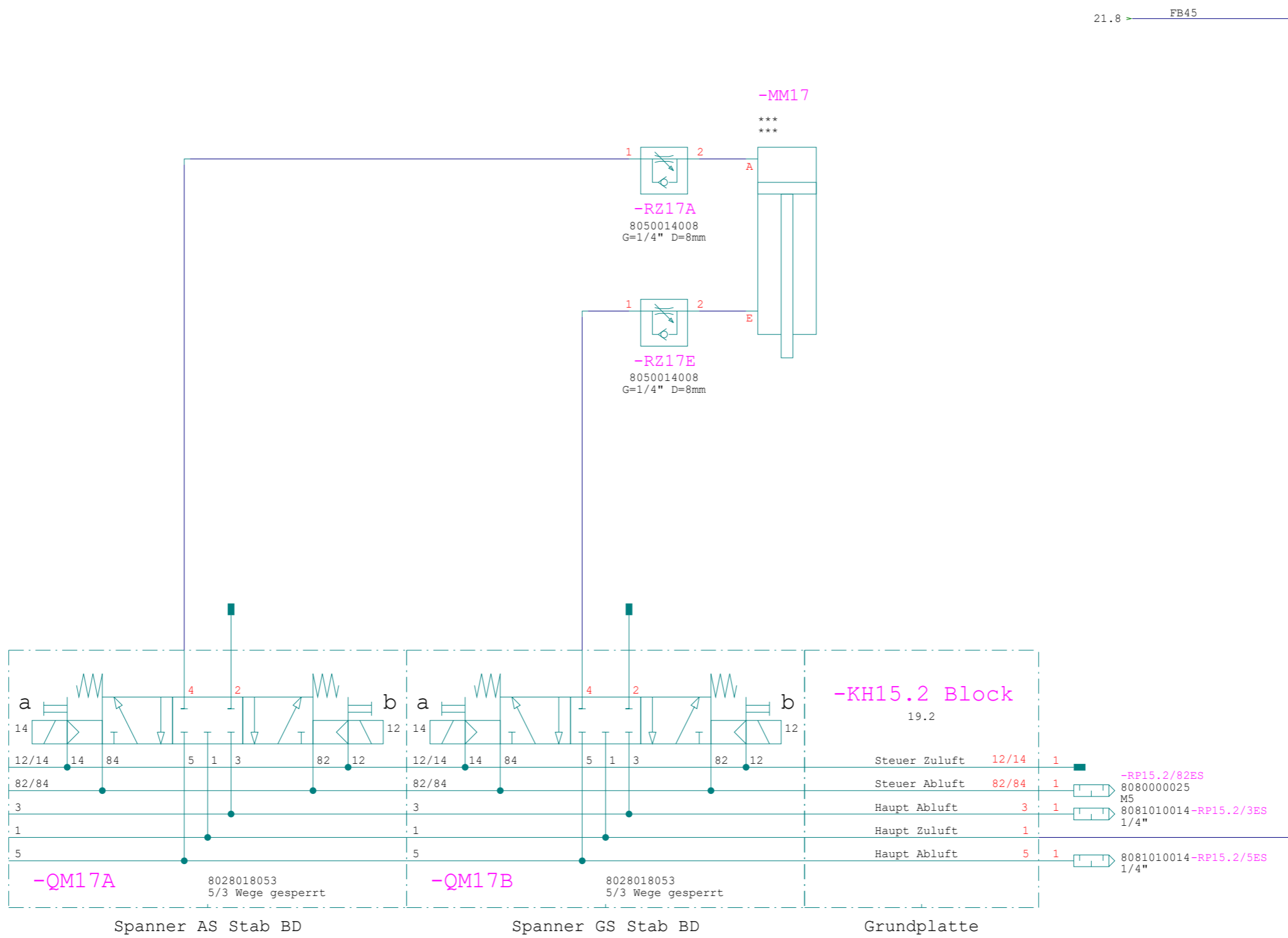

		Datum	07.08.2019	SMH-510-4 Rotox sp.z.o.o.		SMH-510-4-64P__5010000002-0020		=	
		Bearb.	Justus					+	
		Gepr.							
Zust.	Änderung	Datum	Name	Norm	Urspr.	Ers.f	Ers.d	MNR:	von 45 Blatt 23



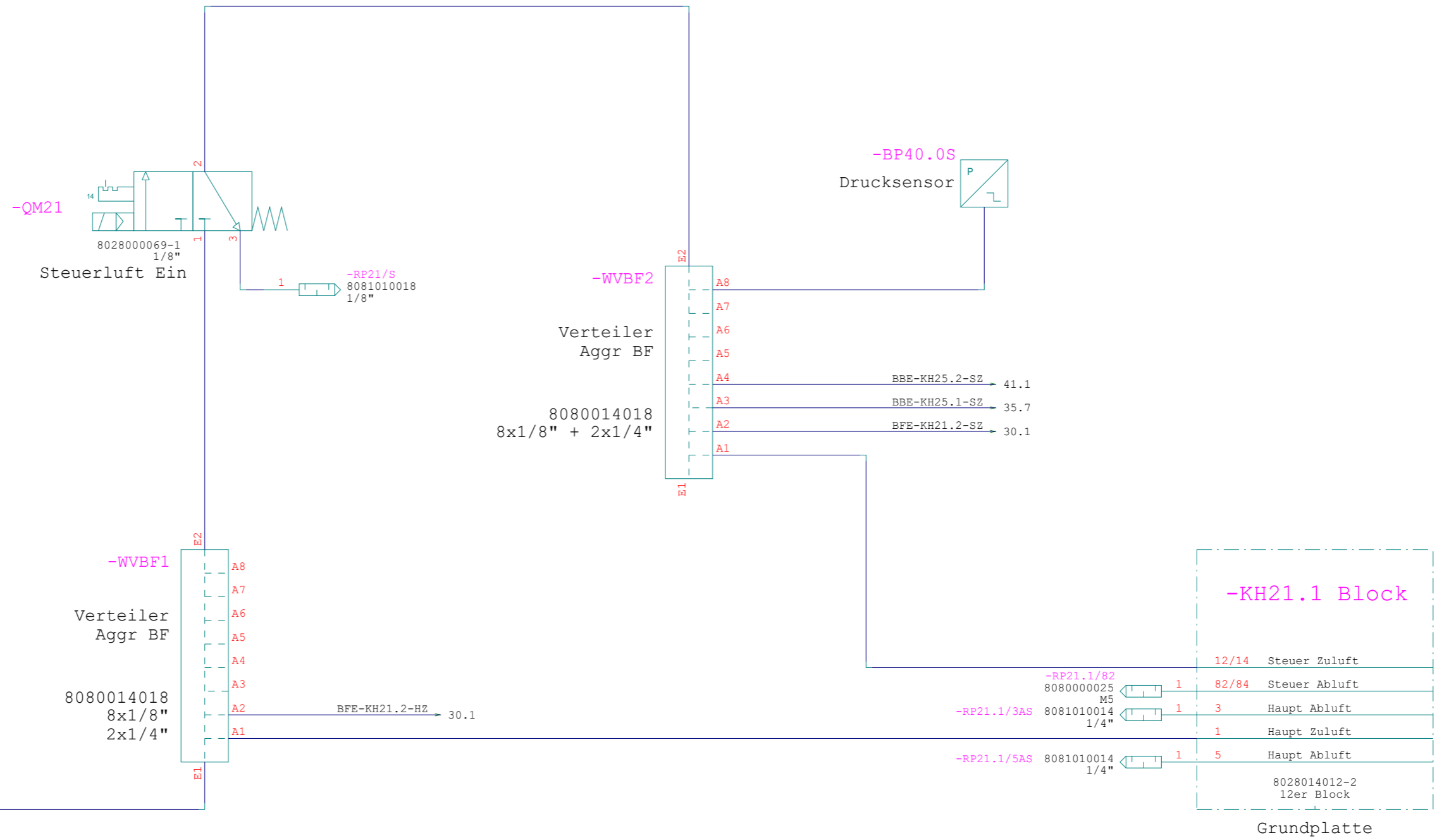

Aggr. BFE KH21.1 Block

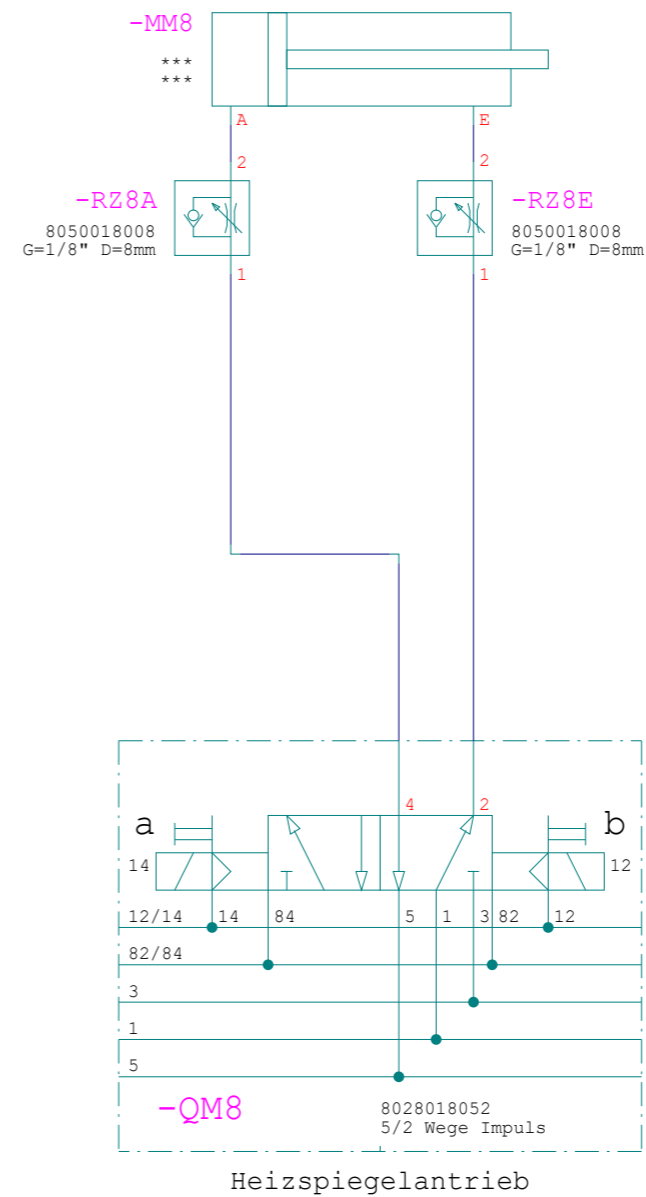
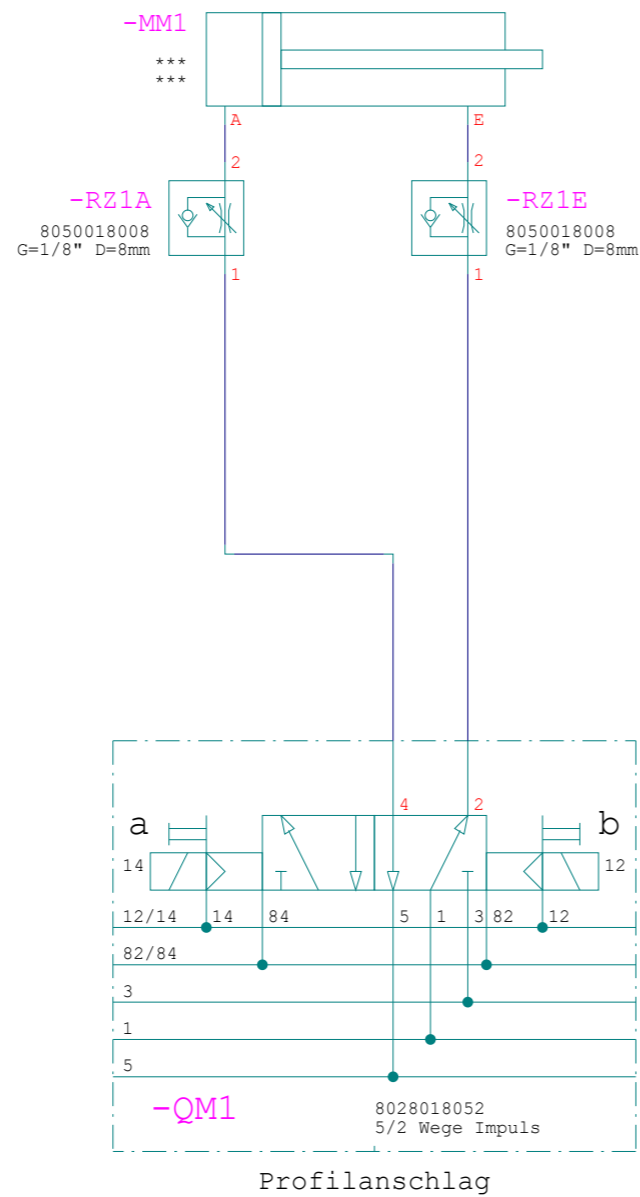

Aggr. BFE KH21.1 Block

				Datum	07.08.2019	SMH-510-4							
				Bearb.	Justus	Rotox sp.z.o.o.		<b>ROTOX</b>		SMH-510-4-64P__5010000002-0020			
				Gepr.						MNR:		von 45	
Zust.	Änderung	Datum	Name	Norm	Urspr.	Ers.f	Ers.d						

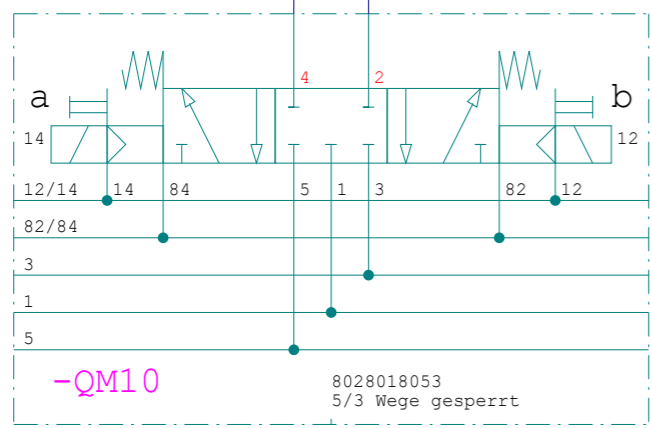
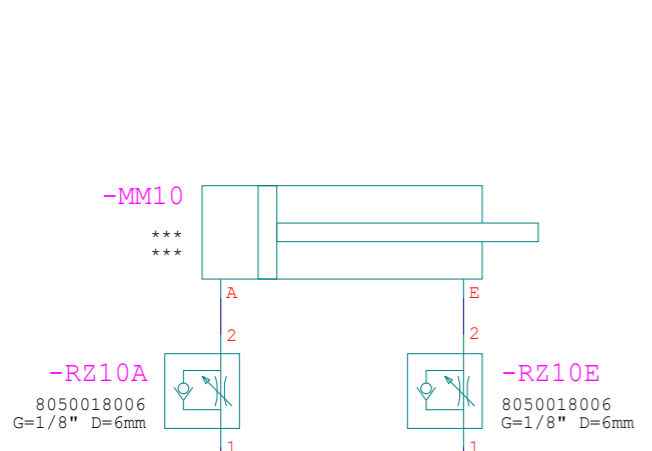

Spannerverschiebung Stab BD

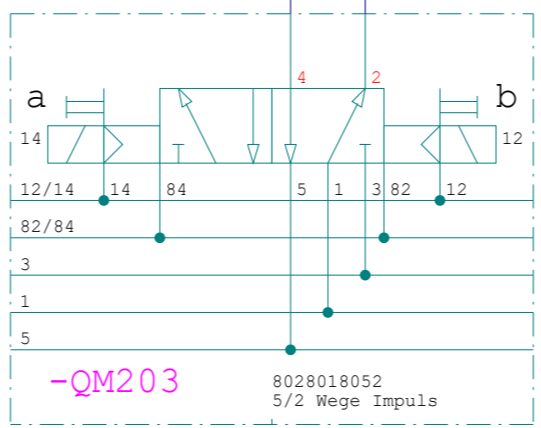
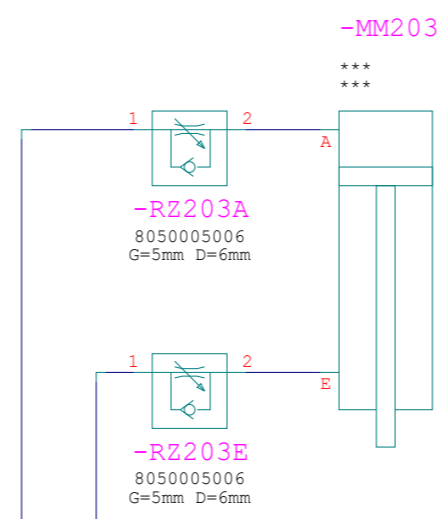

Riegel Kopfverschiebung

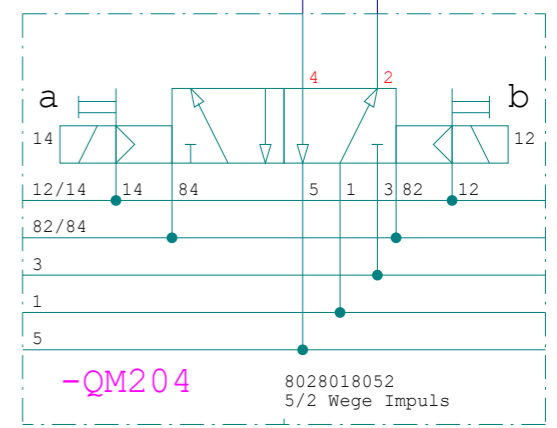
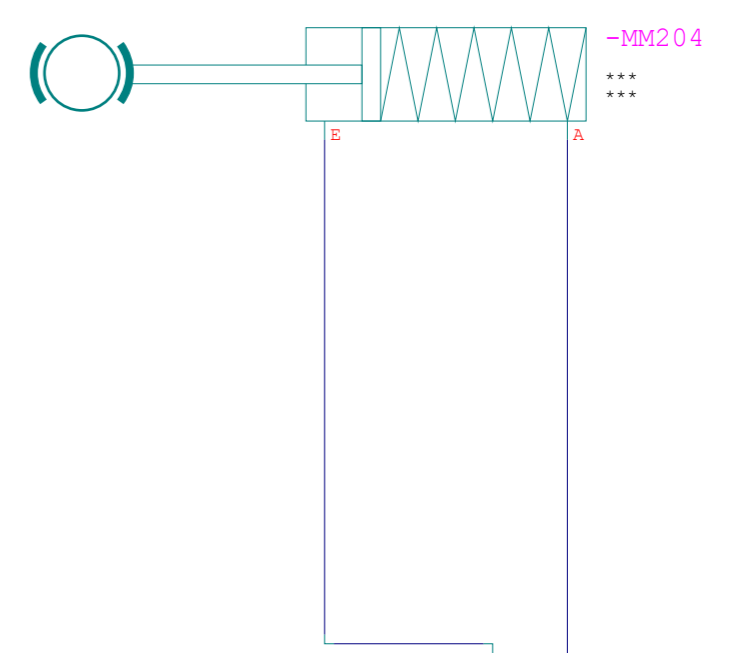

Bremse Kopfverschiebung

Aggr. BFE KH21.1 Block

				Datum	07.08.2019	SMH-510-4							
				Bearb.	Justus	Rotox sp.z.o.o.							
				Gepr.									
Zust.	Änderung	Datum	Name	Norm	Urspr.	Ers.f	Ers.d	SMH-510-4-64P__5010000002-0020		MNR:		von 45	
												Blatt 26	



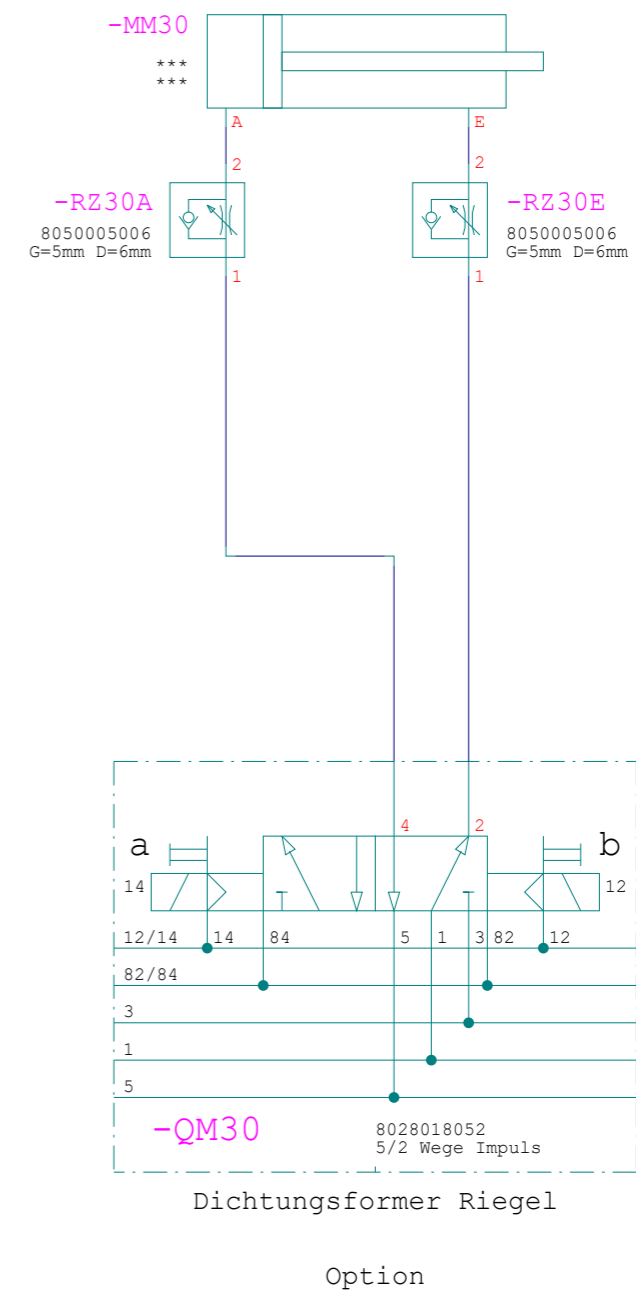
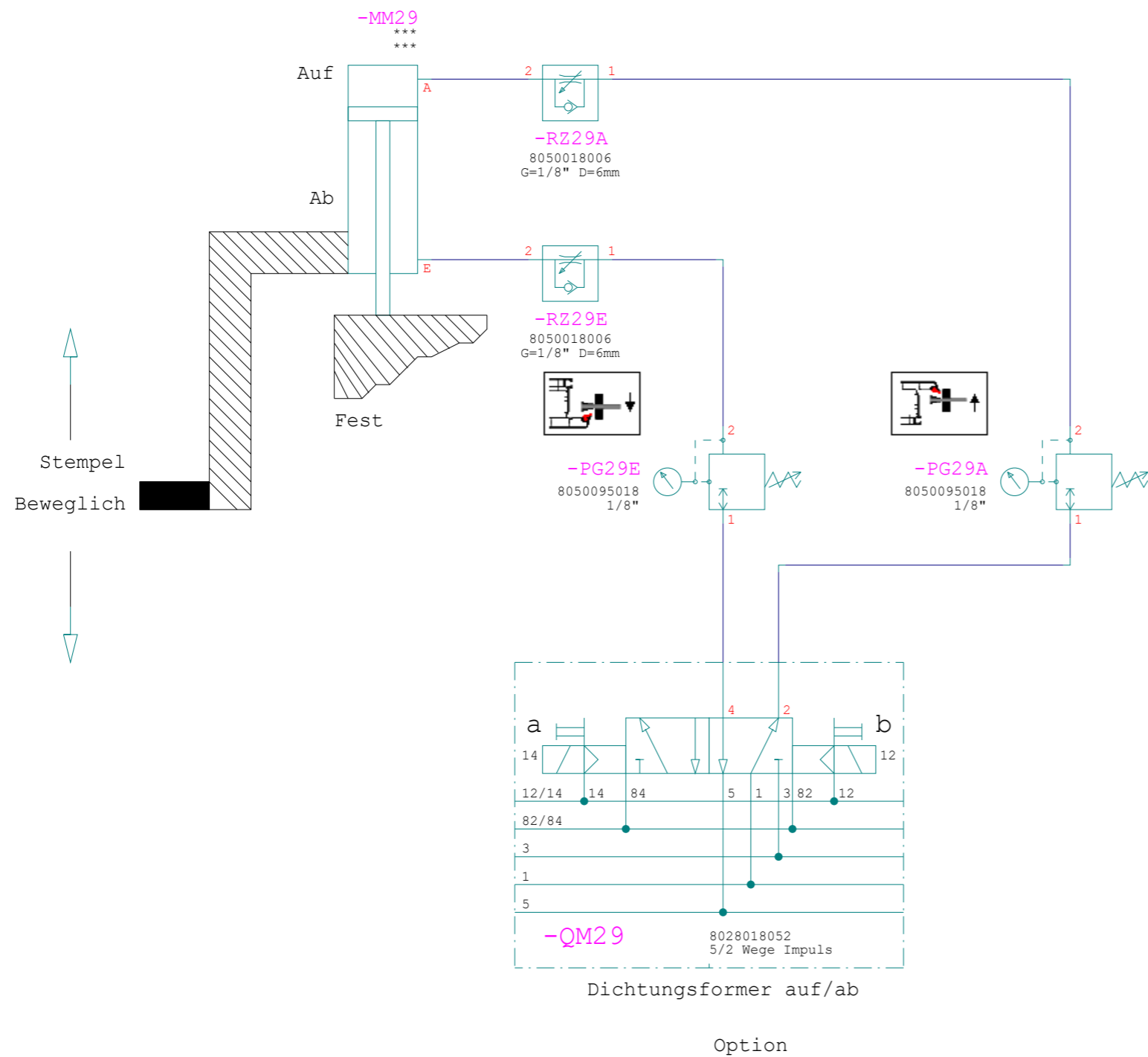

Aggr. BFE KH21.1 Block

				Datum	07.08.2019	SMH-510-4 Rotox sp.z.o.o.		SMH-510-4-64P__5010000002-0020		=	
				Bearb.	Justus					+	
				Gepr.							
Zust.	Änderung	Datum	Name	Norm	Urspr.	Ers.f	Ers.d	MNR:		von 45	Blatt 27



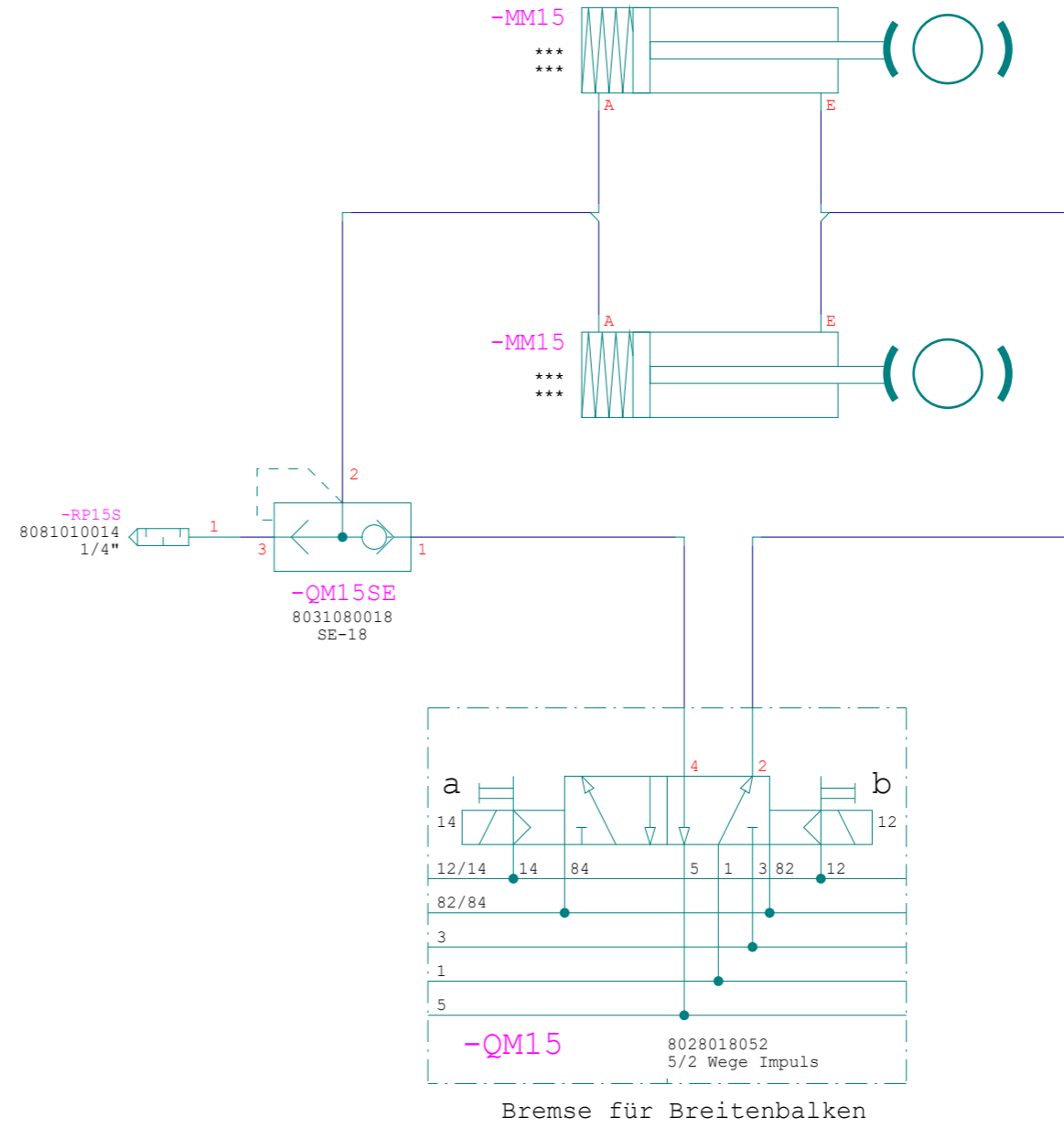
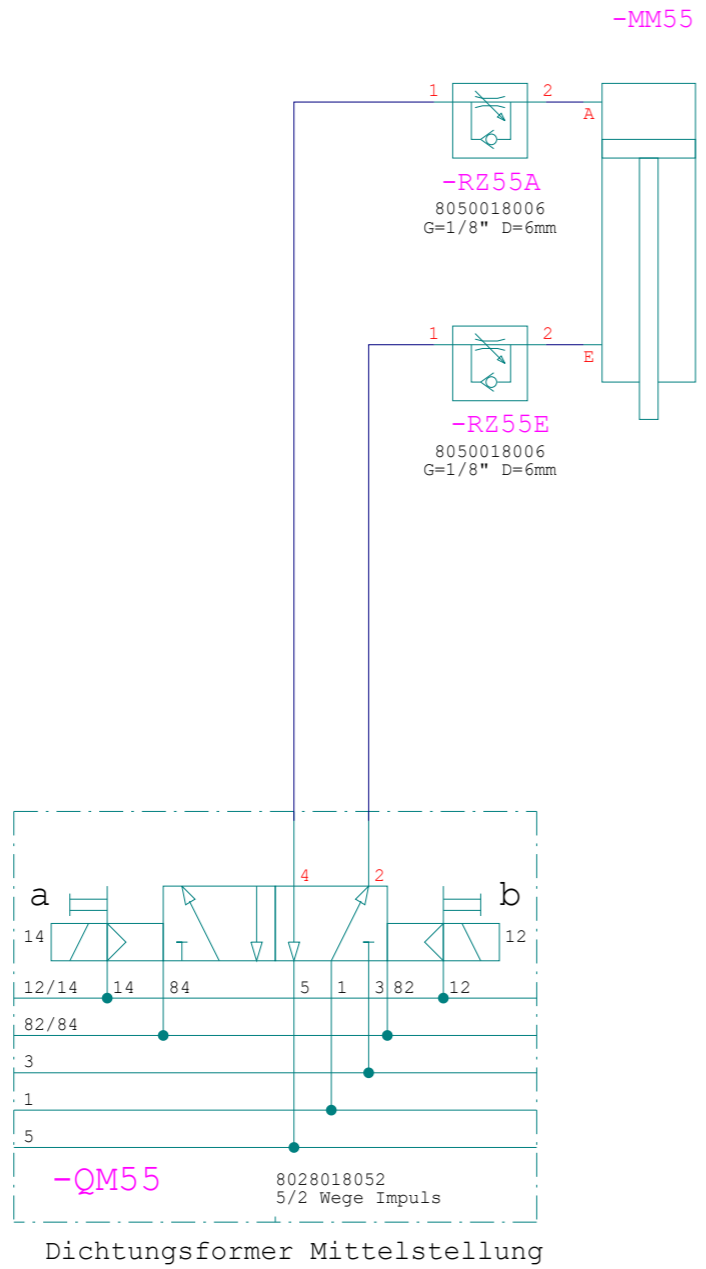

Aggr. BFE KH21.1 Block

				Datum	07.08.2019	SMH-510-4		=	
				Bearb.	Justus	Rotox sp.z.o.o.		+	
				Gepr.					
Zust.	Änderung	Datum	Name	Norm	Urspr.	Ers.f	Ers.d	MNR:	von 45
									Blatt 28



SMH-510-4-64P\_\_5010000002-0020

MNR:

von 45

Blatt 28

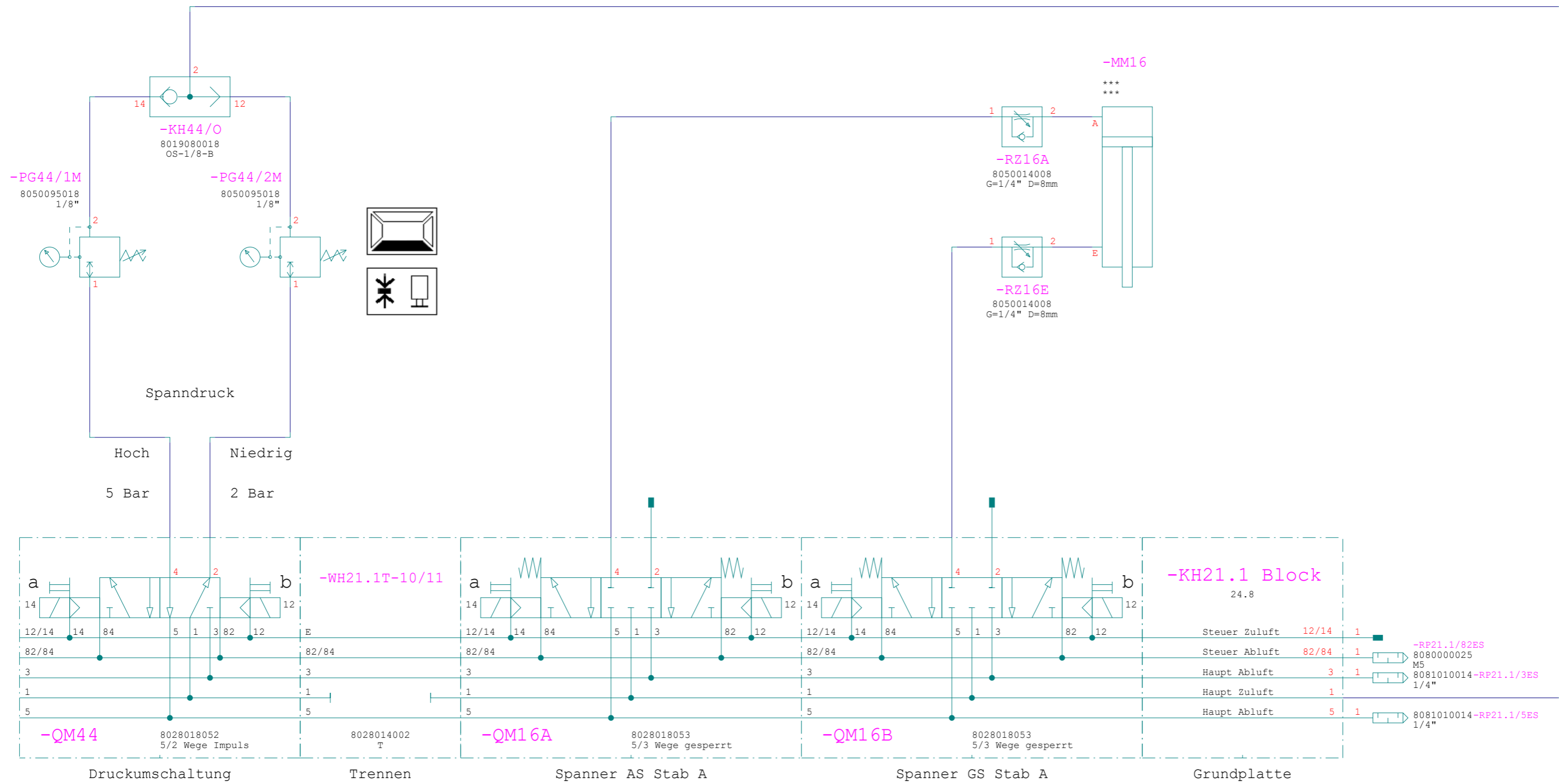

Aggr. BFE KH21.1 Block

		Datum	07.08.2019	SMH-510-4 Rotox sp.z.o.o.		SMH-510-4-64P__5010000002-0020		=	
		Bearb.	Justus					+	
		Gepr.							
Zust.	Änderung	Datum	Name	Norm	Urspr.	Ers.f	Ers.d	MNR:	von 45 Blatt 29



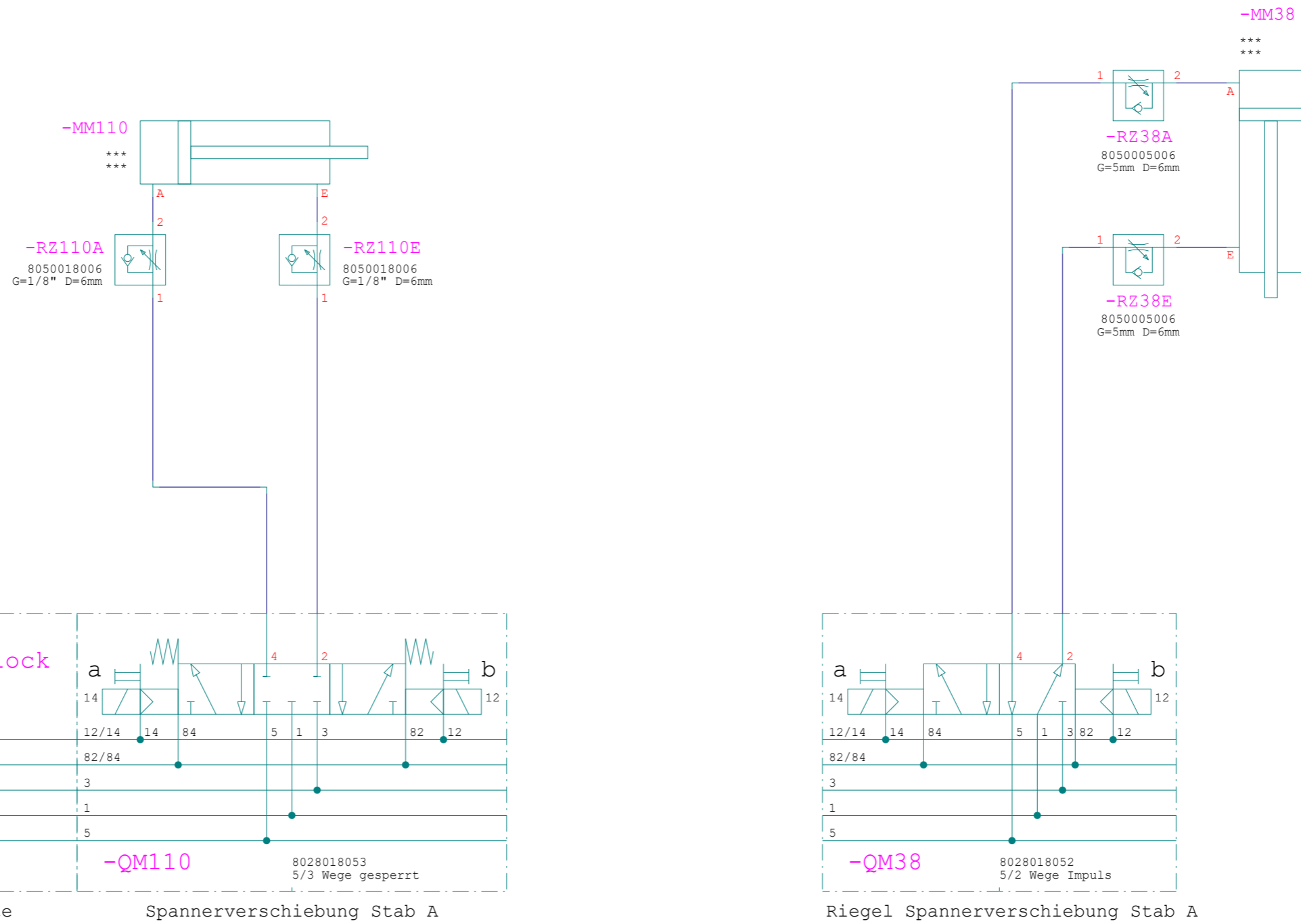

Aggr. BFE KH21.2 Block

				Datum	07.08.2019	SMH-510-4				SMH-510-4-64P__5010000002-0020		=
				Bearb.	Justus	Rotox sp.z.o.o.		ROTOX®				+
				Gepr.						MNR:		von 45
Zust.	Änderung	Datum	Name	Norm	Urspr.	Ers.f	Ers.d					Blatt 30

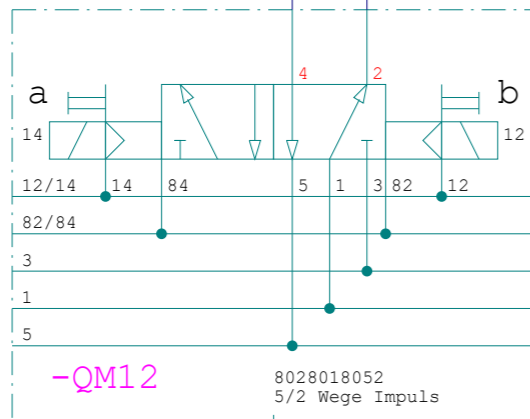
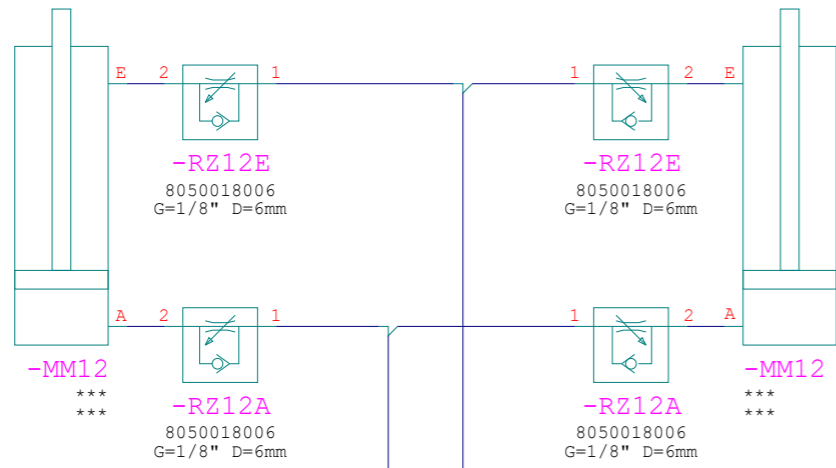

Abtransport Ausheber

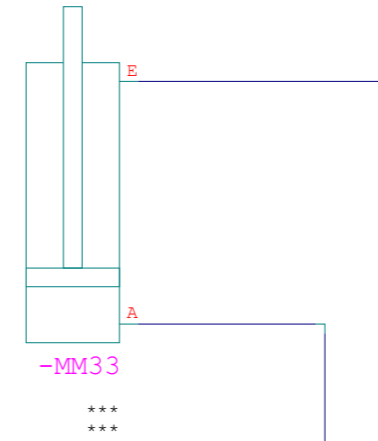

Höheprofil

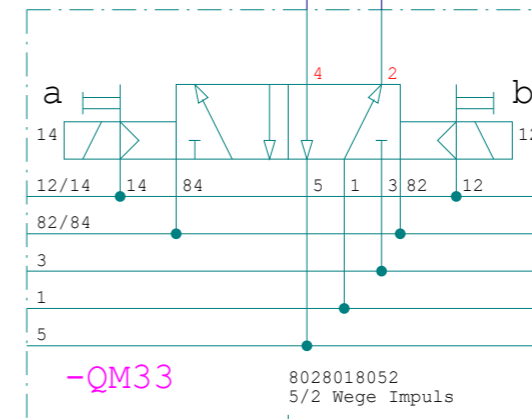

Werkzeuganhebung

Option

Aggr. BFE KH21.2 Block

				Datum	07.08.2019	SMH-510-4							
				Bearb.	Justus	Rotox sp.z.o.o.							
				Gepr.									
Zust.	Änderung	Datum	Name	Norm	Urspr.	Ers.f	Ers.d	SMH-510-4-64P__5010000002-0020		MNR:		=	
												+	
												von 45	Blatt 31



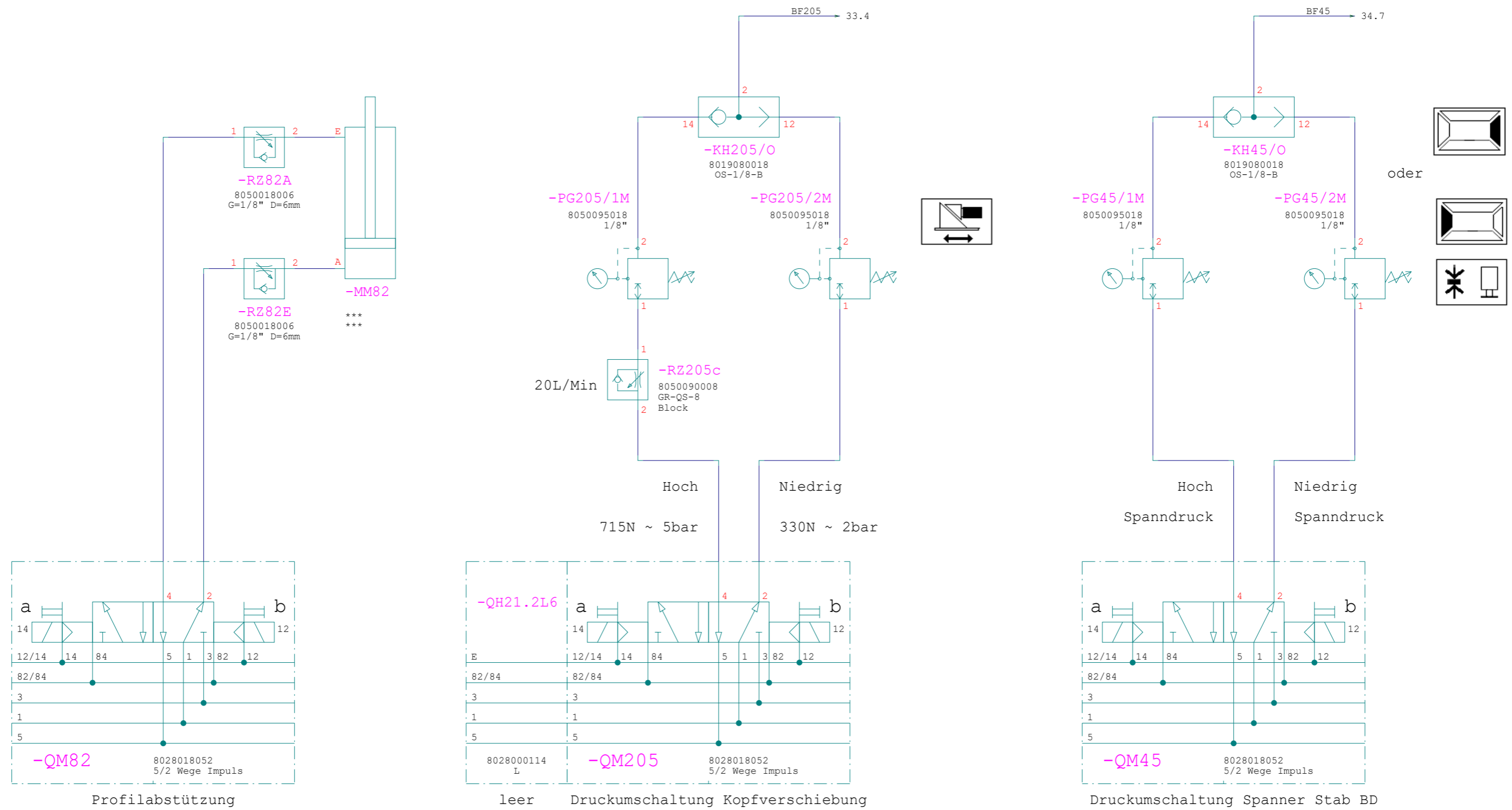

Aggr. BFE KH21.2 Block

Datum		07.08.2019		SMH-510-4		=	
Bearb.		Justus		Rotox sp.z.o.o.		+	
Gepr.							
Zust.	Änderung	Datum	Name	Norm	Urspr.	Ers.f	Ers.d
						MNR:	
						von 45	
						Blatt 32	



SMH-510-4-64P\_\_5010000002-0020

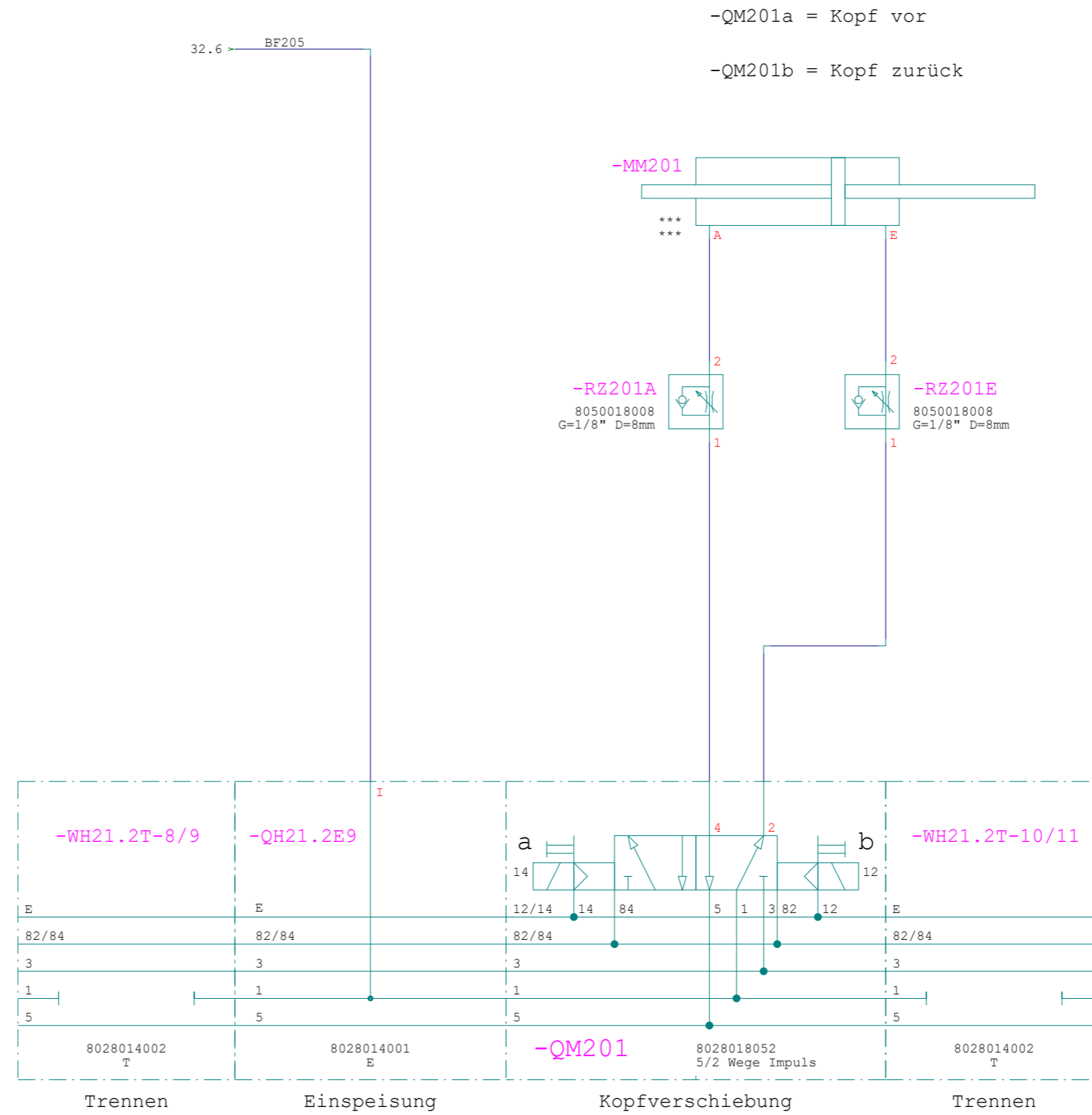

Aggr. BFE KH21.2 Block

		Datum	07.08.2019	SMH-510-4 Rotox sp.z.o.o.		<b>ROTOX</b>	SMH-510-4-64P__5010000002-0020		=	
		Bearb.	Justus						+	
		Gepr.								
Zust.	Änderung	Datum	Name	Norm	Urspr.	Ers.f	Ers.d	MNR:	von 45	Blatt 33

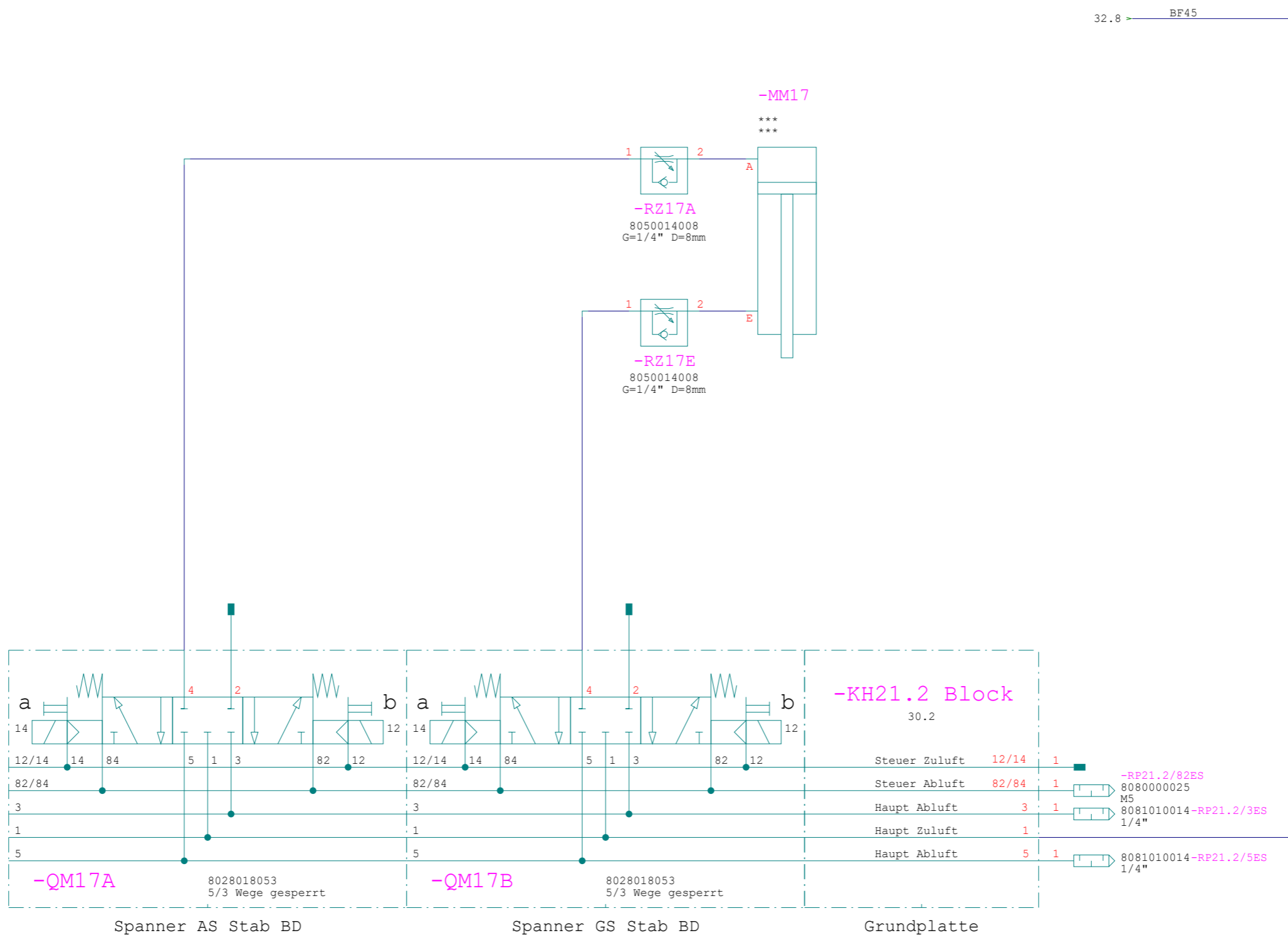

Aggr. BFE KH21.2 Block

Datum	07.08.2019	SMH-510-4	<b>ROTOX</b>		SMH-510-4-64P__5010000002-0020	=
Bearb.	Justus	Rotox sp.z.o.o.			MNR:	von 45
Gepr.		Urspr.	Ers.f	Ers.d		Blatt 34
Zust.	Änderung	Datum	Name	Norm		



Aggr. BBE KH25.1 Block

				Datum	07.08.2019	SMH-510-4							
				Bearb.	Justus	Rotox sp.z.o.o.							
				Gepr.									
Zust.	Änderung	Datum	Name	Norm	Urspr.	Ers.f	Ers.d	SMH-510-4-64P__5010000002-0020		MNR:		von 45 Blatt 35	





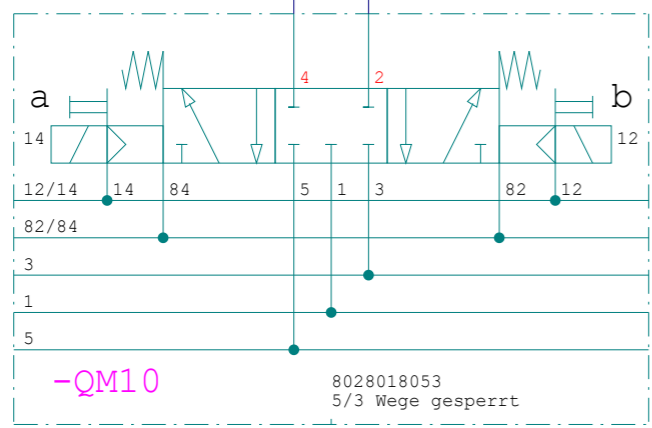
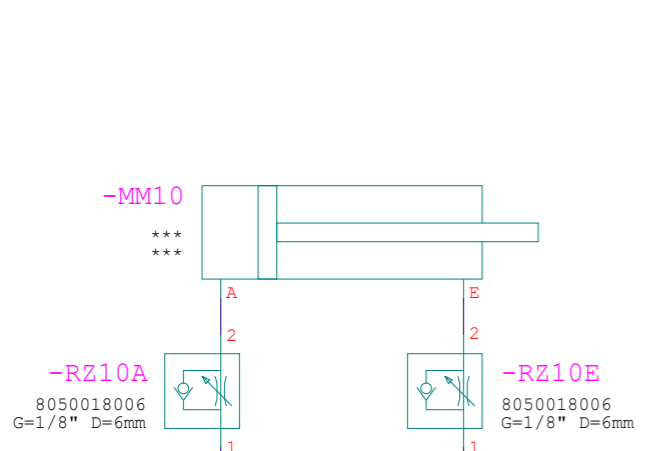

Spannerschiebung Stab BD

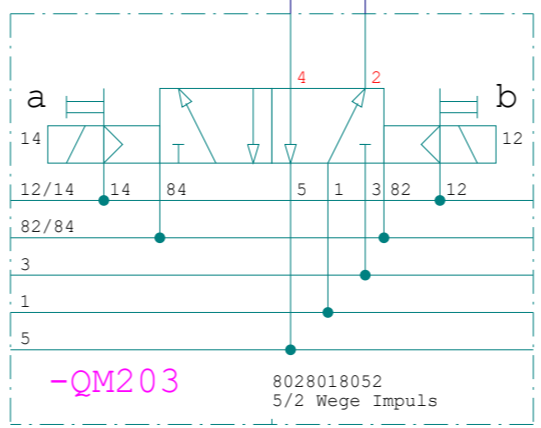
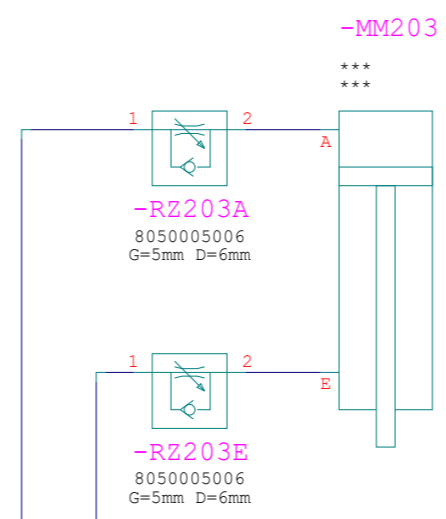

Riegel Kopfverschiebung

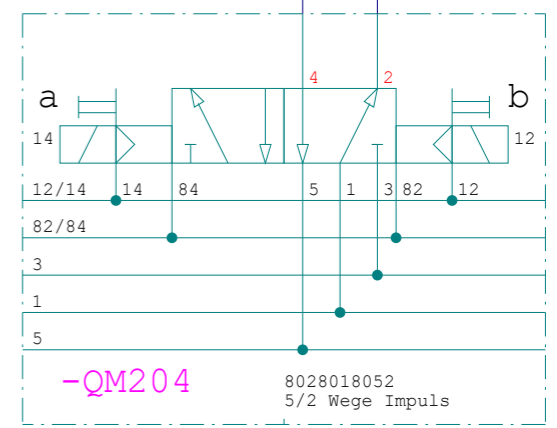
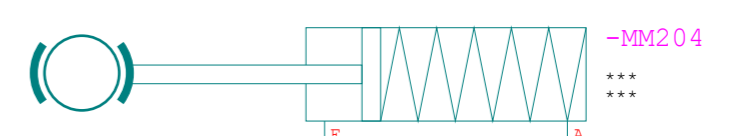

Bremse Kopfverschiebung

Aggr. BBE KH25.1 Block

				Datum	07.08.2019	SMH-510-4							
				Bearb.	Justus	Rotox sp.z.o.o.				SMH-510-4-64P__5010000002-0020			
				Gepr.									
Zust.	Änderung	Datum	Name	Norm	Urspr.	Ers.f	Ers.d			MNR:	von 45	Blatt 37	





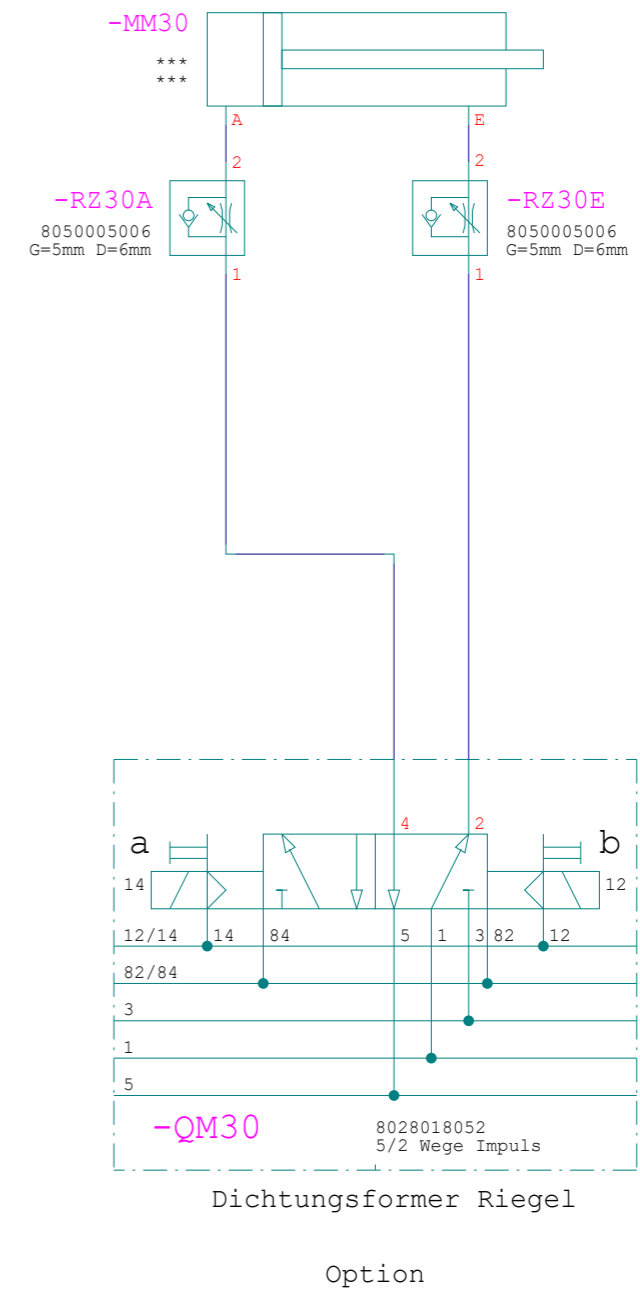
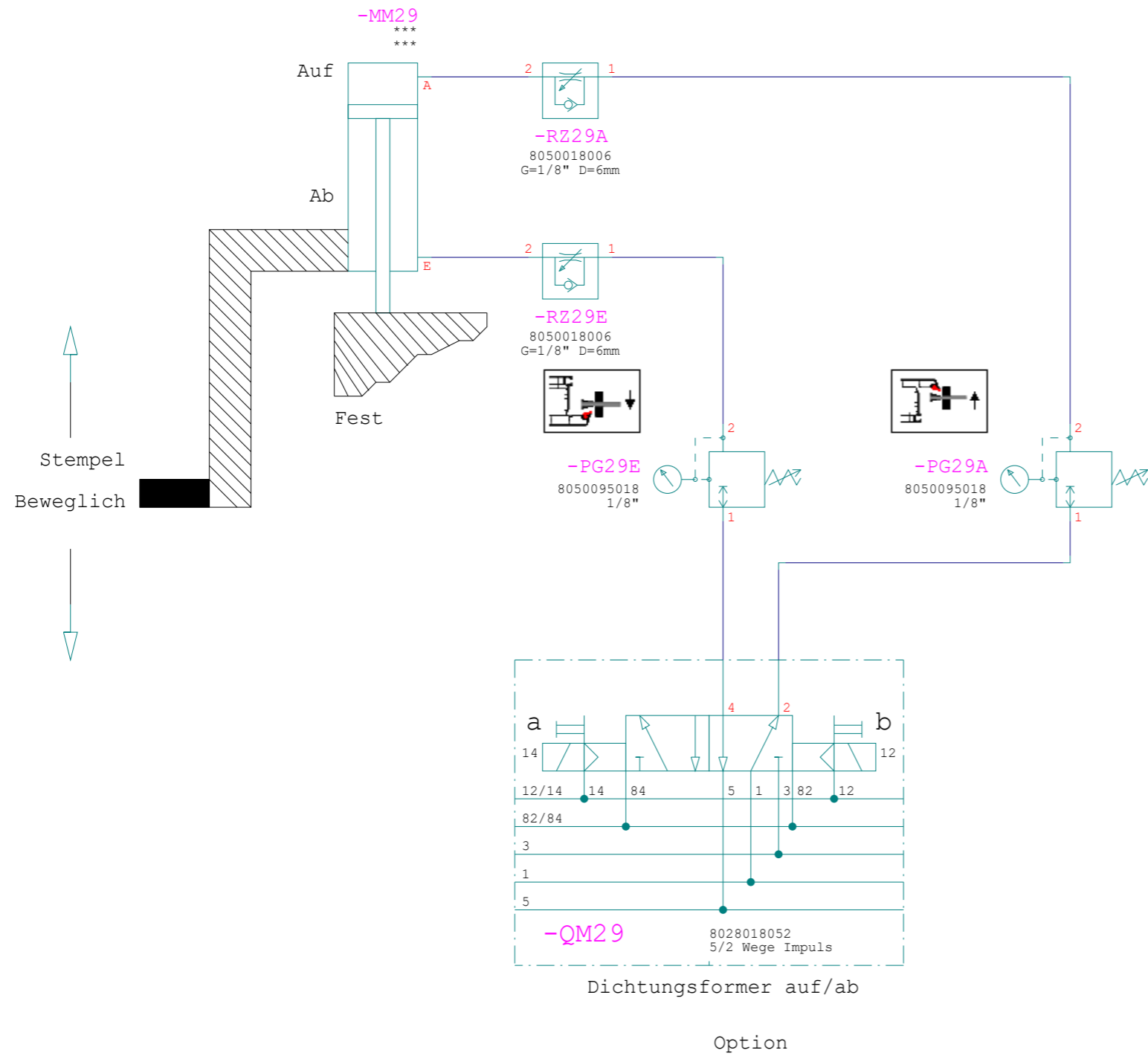

Aggr. BBE KH25.1 Block

				Datum	07.08.2019	SMH-510-4 Rotox sp.z.o.o.				=	
				Bearb.	Justus					+	
				Gepr.							
Zust.	Änderung	Datum	Name	Norm	Urspr.	Ers.f	Ers.d	MNR:		von 45	Blatt 38



SMH-510-4-64P\_\_5010000002-0020

MNR:

von 45

Blatt 38



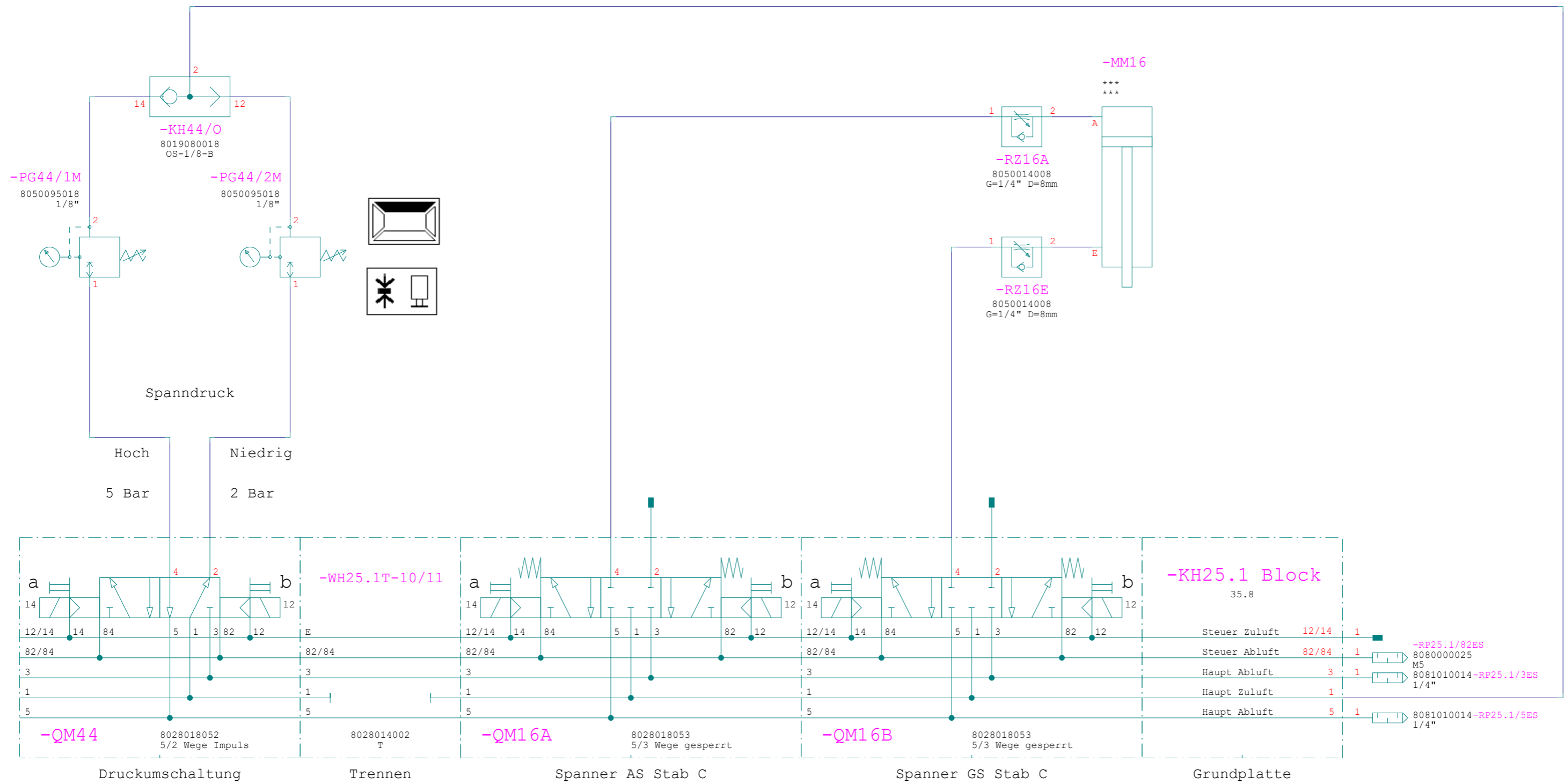

Aggr. BBE KH25.1 Block

		Datum	07.08.2019	SMH-510-4 Rotox sp.z.o.o.		SMH-510-4-64P__5010000002-0020			
		Bearb.	Justus						
		Gepr.							
Zust.	Änderung	Datum	Name	Norm	Urspr.	Ers.f	Ers.d	MNR:	von 45 Blatt 40



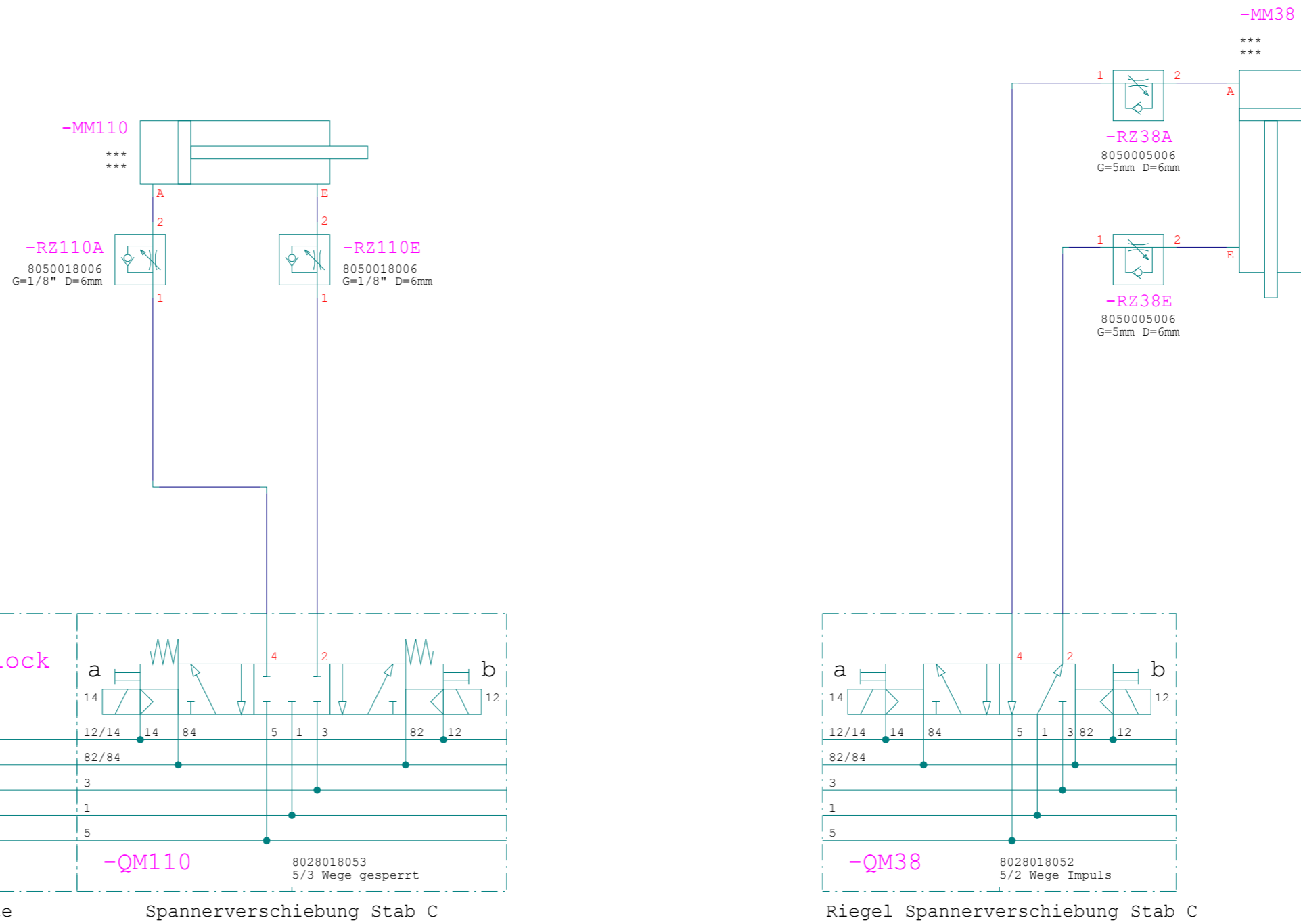

Aggr. BBE KH25.2 Block

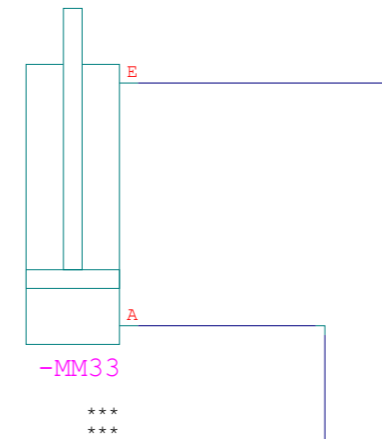

Höheprofil

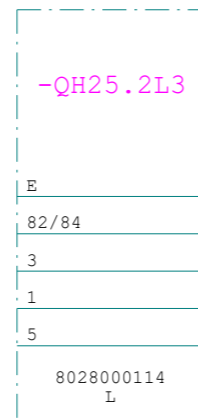

leer

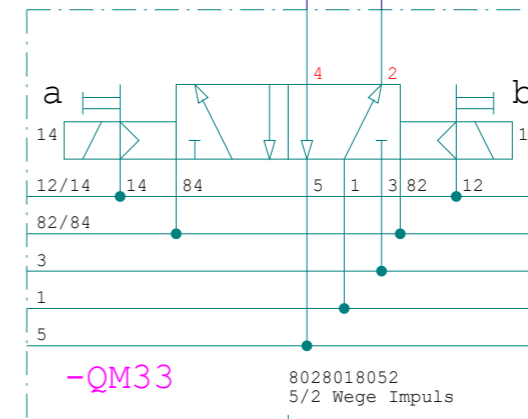

Werkzeuganhebung

Option

Aggr. BBE KH25.2 Block

				Datum	07.08.2019	SMH-510-4							
				Bearb.	Justus	Rotox sp.z.o.o.							
				Gepr.									
Zust.	Änderung	Datum	Name	Norm		Urspr.	Ers.f	Ers.d		MNR:		von 45	Blatt 42



SMH-510-4-64P\_\_5010000002-0020

=  
+

MNR:

von 45

Blatt 42



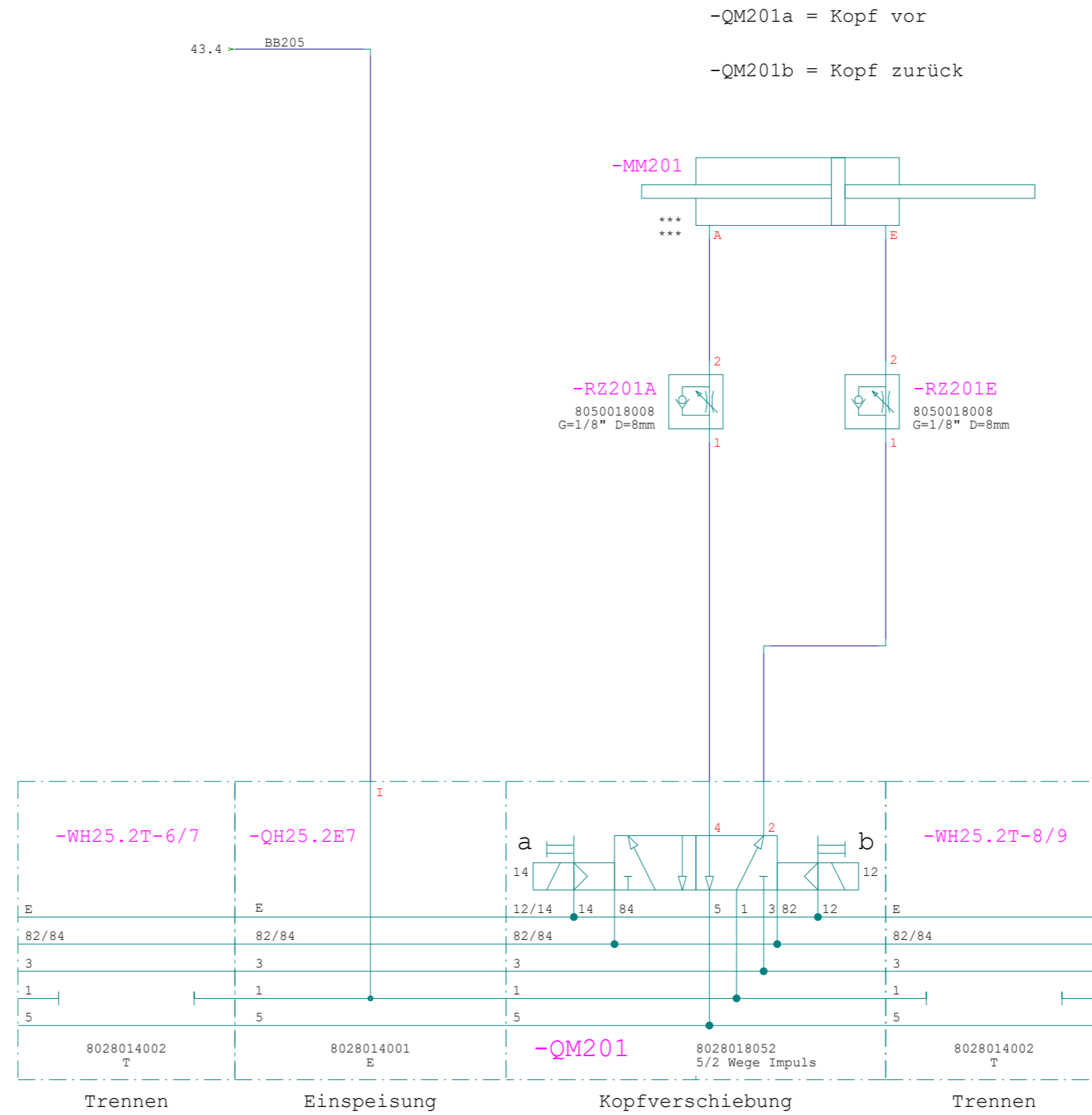

Aggr. BBE KH25.2 Block

		Datum	07.08.2019	SMH-510-4 Rotox sp.z.o.o.		<b>ROTOX</b>	SMH-510-4-64P__5010000002-0020		=	
		Bearb.	Justus						+	
		Gepr.								
Zust.	Änderung	Datum	Name	Norm	Urspr.	Ers.f	Ers.d	MNR:	von 45	Blatt 44

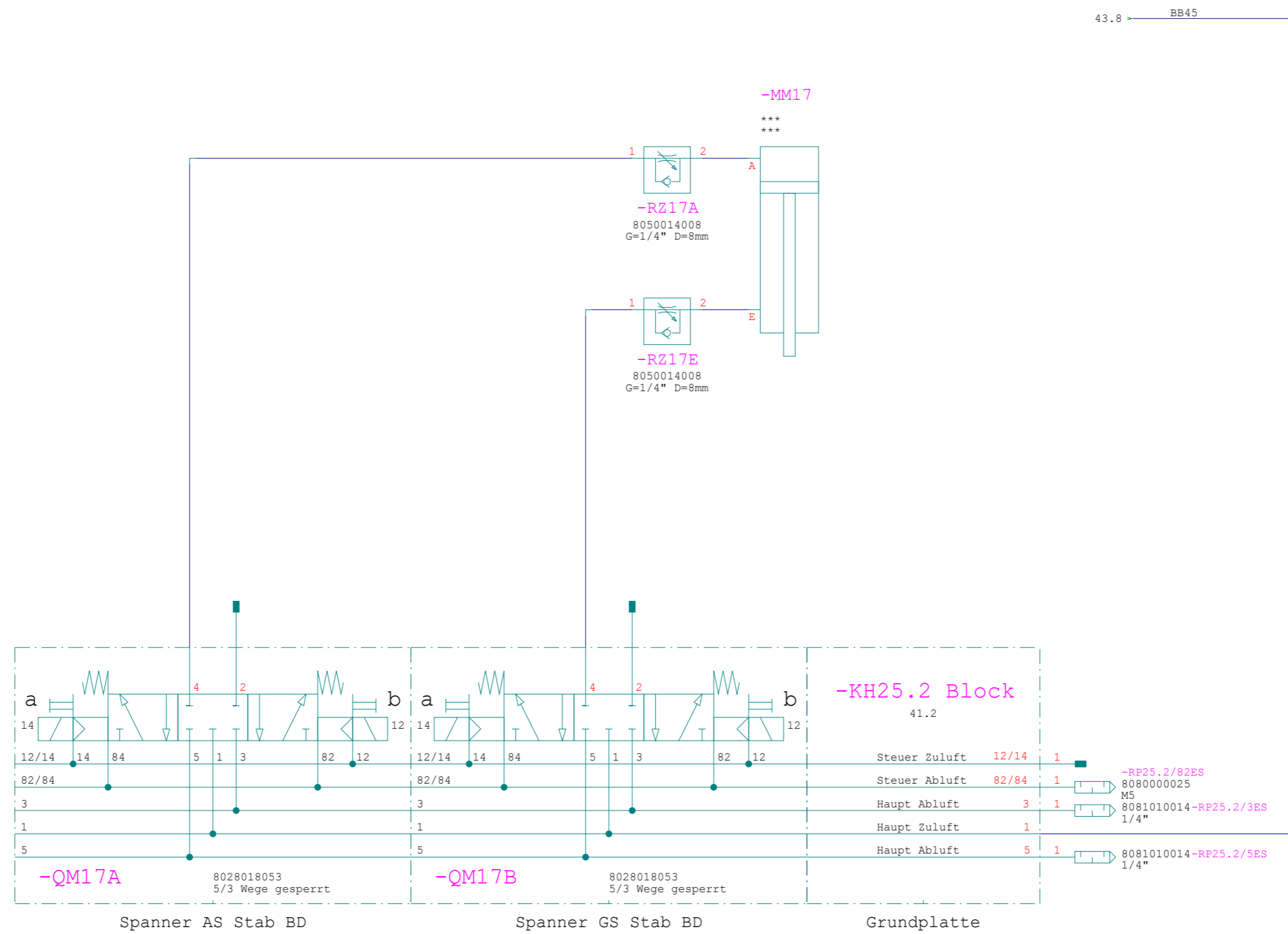

Aggr. BBE KH25.2 Block

		Datum	07.08.2019	SMH-510-4 Rotox sp.z.o.o.		SMH-510-4-64P__5010000002-0020		=
		Bearb.	Justus					+
		Gepr.						
Zust.	Änderung	Datum	Name	Norm	Urspr.	Ers.f	Ers.d	MNR: von 45 Blatt 45









Einbaulage der Manometer

Stab AC  
niedriger Spanndruck

2 bar

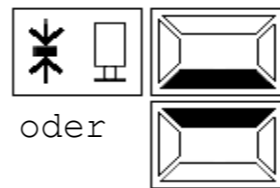
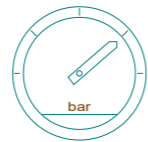

2 bar

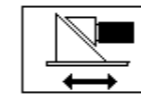

Kopfverschiebung  
niedriger Druck

Stab AC  
hoher Spanndruck

5 bar

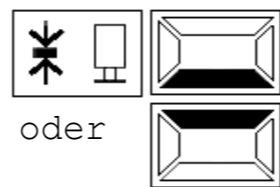

5 bar

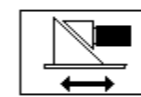
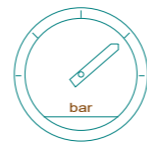

Kopfverschiebung  
hoher Druck

Stab BD  
niedriger Spanndruck

2 bar

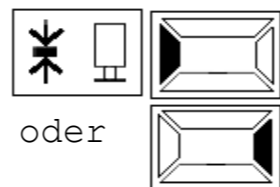
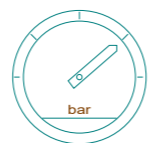

3 bar

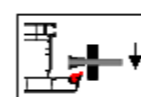
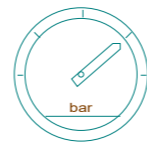

Dichtungsformer ab

Stab BD  
hoher Spanndruck

5 bar

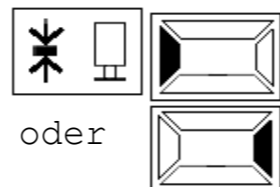

3 bar

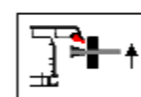

Dichtungsformer auf

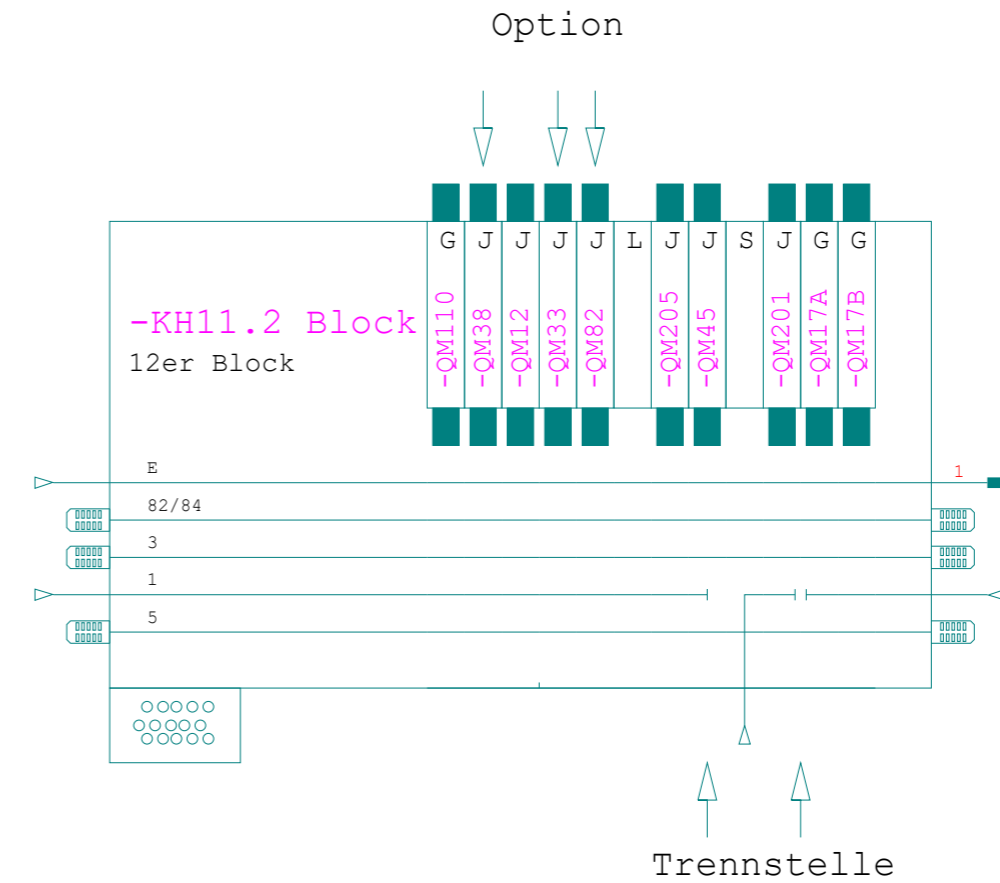
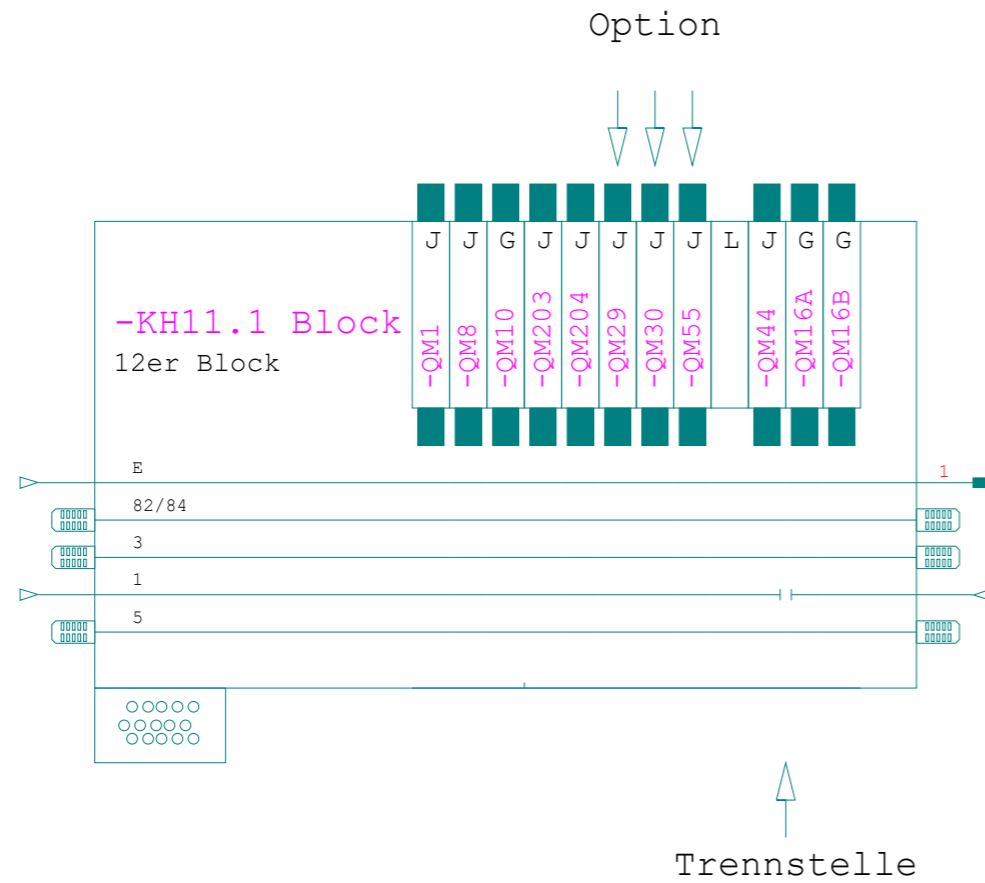

L	80 28 000 114	Festo VTUG	VABB-L1-14-T	= Verschußplatte
S	80 28 014 001	Festo VTUG	VABF-L1-14-P3A4-G18-T1	= Versorgungsplatte
A	80 28 118 052	Festo VTUG	VUVG-S14-M52-MZT-G18-1T1L	= 5/2 Wege Vorsteuerluft
K	80 28 018 232	Festo VTUG	VUVG-S14-T32C-AZT-G18-1T1L	= 2x 3/2 Wege Einfach entlüftet Vorsteuerluft
J	80 28 018 052	Festo VTUG	VUVG-S14-B52-ZT-G18-1T1L	= 5/2 Wege Impuls Vorsteuerluft
G	80 28 018 053	Festo VTUG	VUVG-S14-P53C-ZT-G18-1T1L	= 5/3 Wege Mittelstellung gesperrt Vorsteuerluft
E	80 28 118 053	Festo VTUG	VUVG-S14-P53E-ZT-G18-1T1L	= 5/3 Wege Mittelstellung entlüftet Vorsteuerluft
	80 28 014 004	Festo VTUG	VABM-L1-14G-G14-4-GR	= Grundplatte leer 4 Plätze
	80 28 014 006	Festo VTUG	VABM-L1-14G-G14-6-GR	= Grundplatte leer 6 Plätze
	80 28 014 008	Festo VTUG	VABM-L1-14G-G14-8-GR	= Grundplatte leer 8 Plätze
	80 28 014 010	Festo VTUG	VABM-L1-14G-G14-10-GR	= Grundplatte leer 10 Plätze
	80 28 014 012	Festo VTUG	VABM-L1-14G-G14-12-GR	= Grundplatte leer 12 Plätze

### Übersicht Ventilblöcke

Aggr. FFE

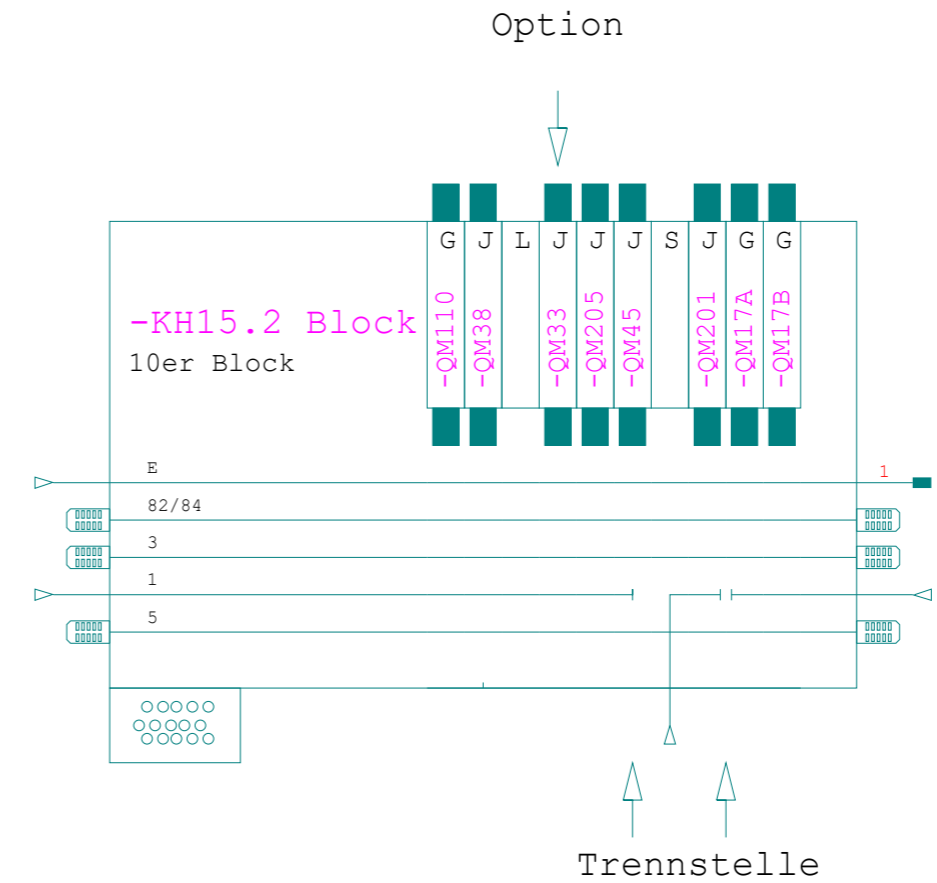
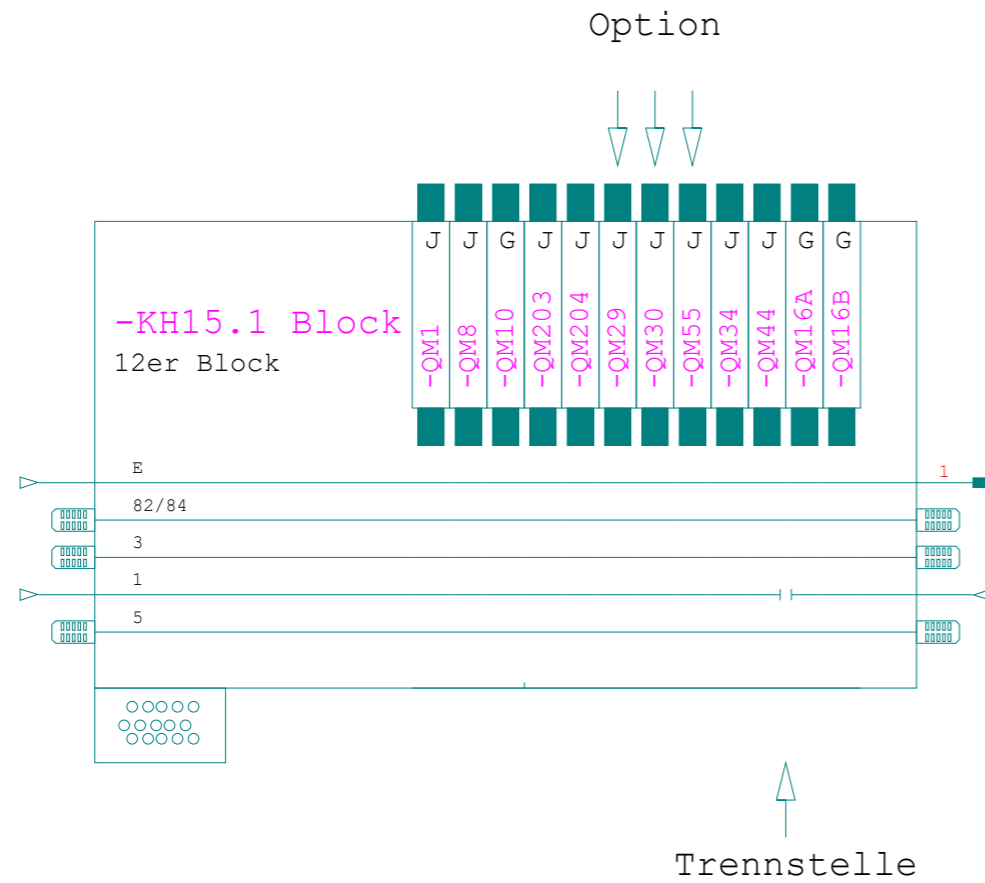

L	80 28 000 114	Festo VTUG	VABB-L1-14-T	= Verschlußplatte
S	80 28 014 001	Festo VTUG	VABF-L1-14-P3A4-G18-T1	= Versorgungsplatte
A	80 28 118 052	Festo VTUG	VUVG-S14-M52-MZT-G18-1T1L	= 5/2 Wege Vorsteuerluft
K	80 28 018 232	Festo VTUG	VUVG-S14-T32C-AZT-G18-1T1L	= 2x 3/2 Wege Einfach entlüftet Vorsteuerluft
J	80 28 018 052	Festo VTUG	VUVG-S14-B52-ZT-G18-1T1L	= 5/2 Wege Impuls Vorsteuerluft
G	80 28 018 053	Festo VTUG	VUVG-S14-P53C-ZT-G18-1T1L	= 5/3 Wege Mittelstellung gesperrt Vorsteuerluft
E	80 28 118 053	Festo VTUG	VUVG-S14-P53E-ZT-G18-1T1L	= 5/3 Wege Mittelstellung entlüftet Vorsteuerluft
80 28 014 004 Festo VTUG VABM-L1-14G-G14-4-GR				= Grundplatte leer 4 Plätze
80 28 014 006 Festo VTUG VABM-L1-14G-G14-6-GR				= Grundplatte leer 6 Plätze
80 28 014 008 Festo VTUG VABM-L1-14G-G14-8-GR				= Grundplatte leer 8 Plätze
80 28 014 010 Festo VTUG VABM-L1-14G-G14-10-GR				= Grundplatte leer 10 Plätze
80 28 014 012 Festo VTUG VABM-L1-14G-G14-12-GR				= Grundplatte leer 12 Plätze

### Übersicht Ventilblöcke

Aggr. FBE

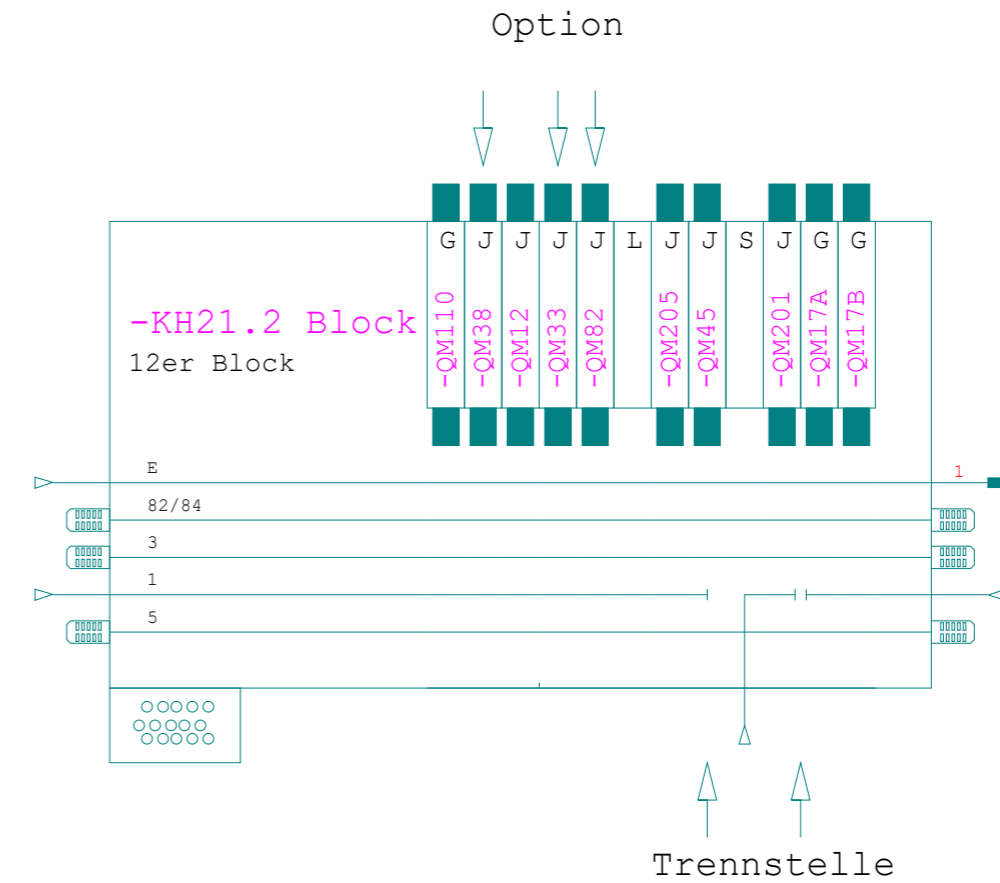
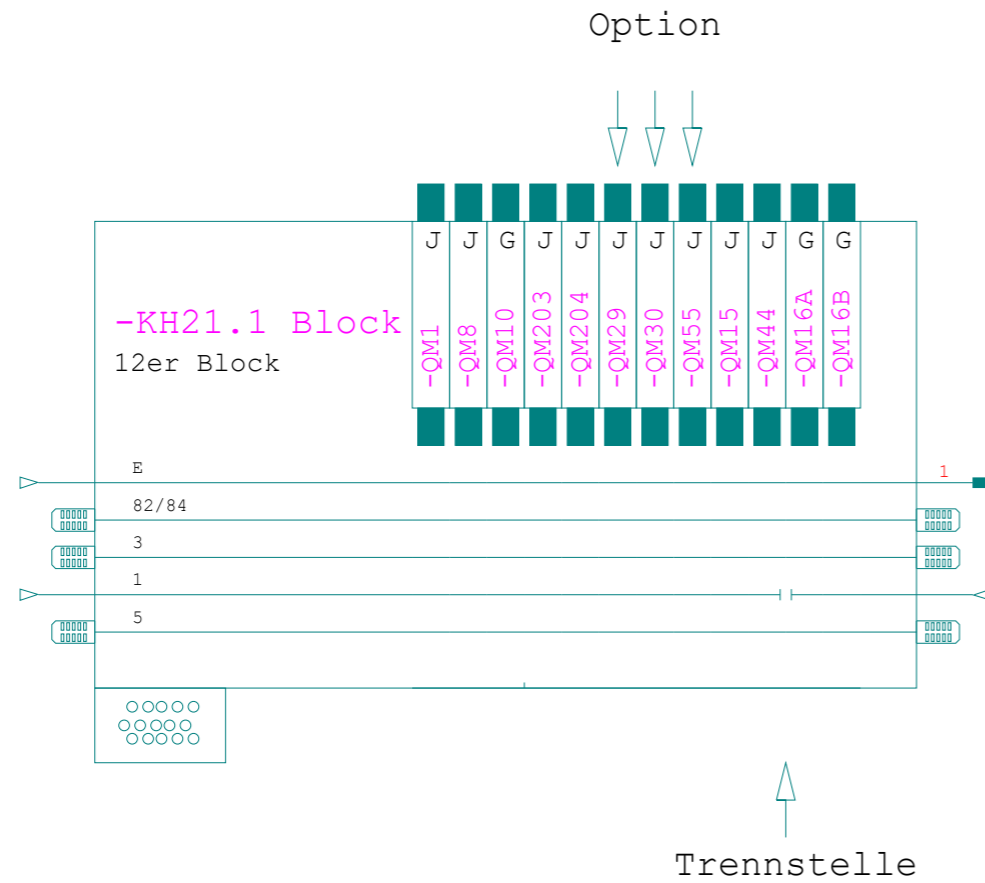

L	80 28 000 114	Festo VTUG	VABB-L1-14-T	= Verschlußplatte
S	80 28 014 001	Festo VTUG	VABF-L1-14-P3A4-G18-T1	= Versorgungsplatte
A	80 28 118 052	Festo VTUG	VUVG-S14-M52-MZT-G18-1T1L	= 5/2 Wege Vorsteuerluft
K	80 28 018 232	Festo VTUG	VUVG-S14-T32C-AZT-G18-1T1L	= 2x 3/2 Wege Einfach entlüftet Vorsteuerluft
J	80 28 018 052	Festo VTUG	VUVG-S14-B52-ZT-G18-1T1L	= 5/2 Wege Impuls Vorsteuerluft
G	80 28 018 053	Festo VTUG	VUVG-S14-P53C-ZT-G18-1T1L	= 5/3 Wege Mittelstellung gesperrt Vorsteuerluft
E	80 28 118 053	Festo VTUG	VUVG-S14-P53E-ZT-G18-1T1L	= 5/3 Wege Mittelstellung entlüftet Vorsteuerluft
	80 28 014 004	Festo VTUG	VABM-L1-14G-G14-4-GR	= Grundplatte leer 4 Plätze
	80 28 014 006	Festo VTUG	VABM-L1-14G-G14-6-GR	= Grundplatte leer 6 Plätze
	80 28 014 008	Festo VTUG	VABM-L1-14G-G14-8-GR	= Grundplatte leer 8 Plätze
	80 28 014 010	Festo VTUG	VABM-L1-14G-G14-10-GR	= Grundplatte leer 10 Plätze
	80 28 014 012	Festo VTUG	VABM-L1-14G-G14-12-GR	= Grundplatte leer 12 Plätze

Übersicht Ventilblöcke

Aggr. BFE

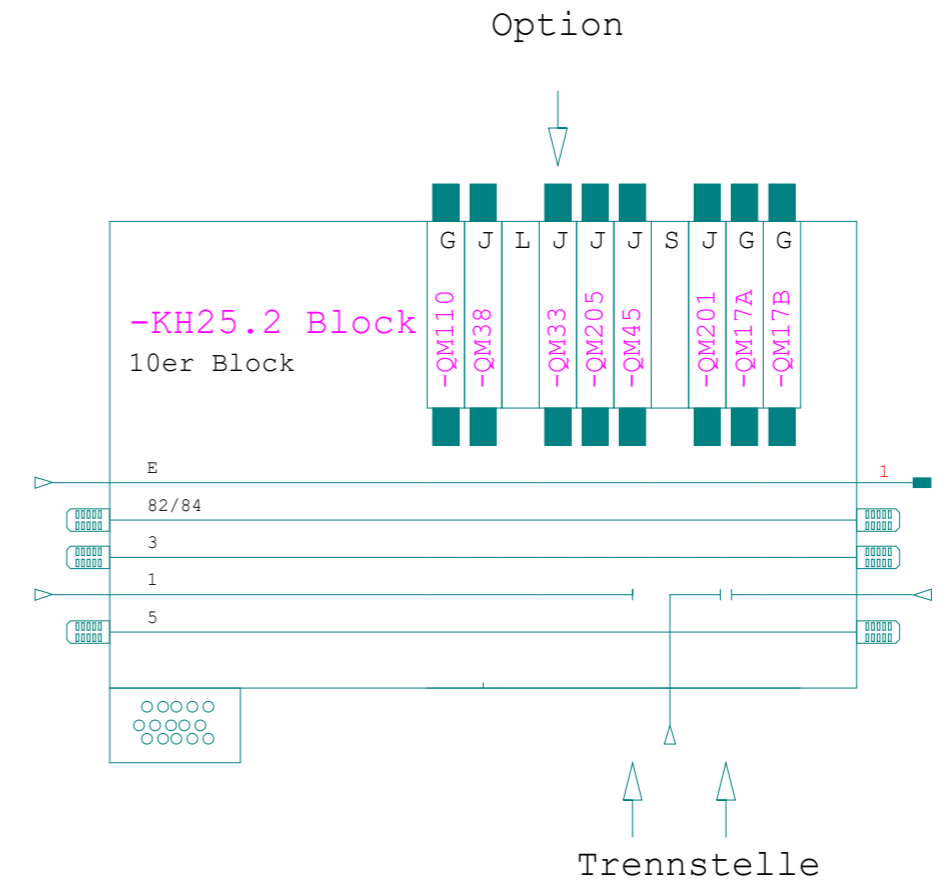
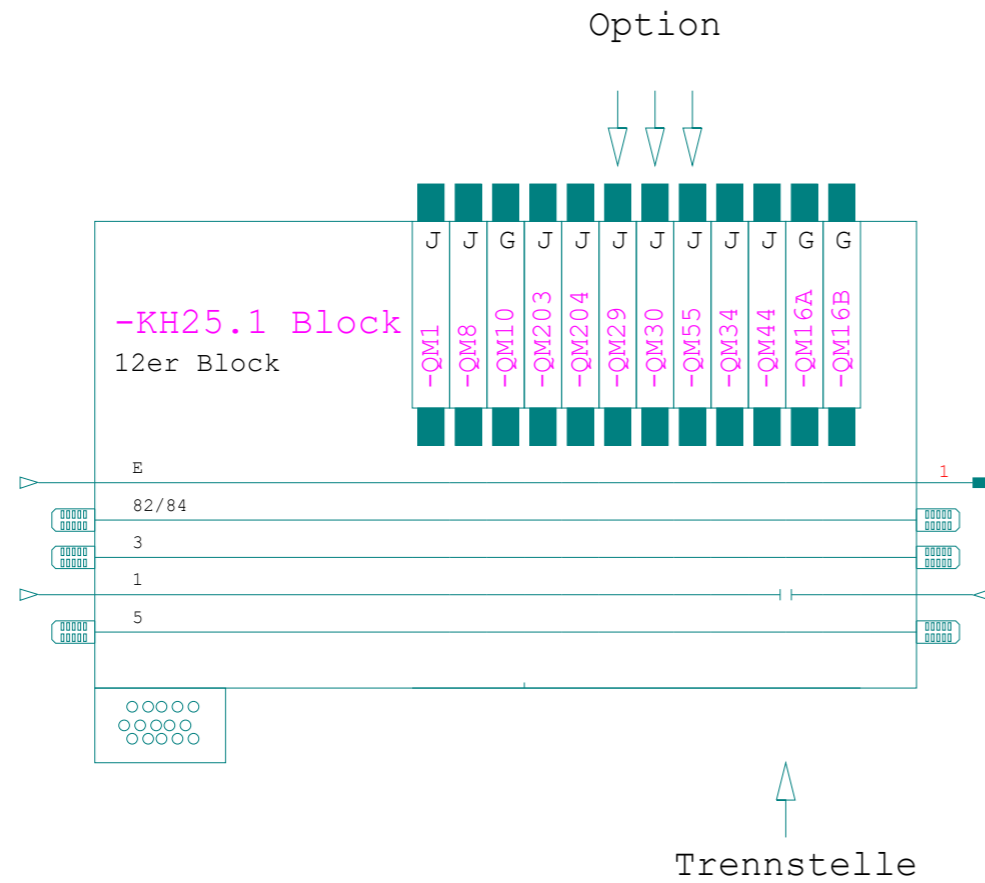

L	80 28 000 114	Festo VTUG	VABB-L1-14-T	= Verschlußplatte
S	80 28 014 001	Festo VTUG	VABF-L1-14-P3A4-G18-T1	= Versorgungsplatte
A	80 28 118 052	Festo VTUG	VUVG-S14-M52-MZT-G18-1T1L	= 5/2 Wege Vorsteuerluft
K	80 28 018 232	Festo VTUG	VUVG-S14-T32C-AZT-G18-1T1L	= 2x 3/2 Wege Einfach entlüftet Vorsteuerluft
J	80 28 018 052	Festo VTUG	VUVG-S14-B52-ZT-G18-1T1L	= 5/2 Wege Impuls Vorsteuerluft
G	80 28 018 053	Festo VTUG	VUVG-S14-P53C-ZT-G18-1T1L	= 5/3 Wege Mittelstellung gesperrt Vorsteuerluft
E	80 28 118 053	Festo VTUG	VUVG-S14-P53E-ZT-G18-1T1L	= 5/3 Wege Mittelstellung entlüftet Vorsteuerluft
80 28 014 004 Festo VTUG VABM-L1-14G-G14-4-GR				= Grundplatte leer 4 Plätze
80 28 014 006 Festo VTUG VABM-L1-14G-G14-6-GR				= Grundplatte leer 6 Plätze
80 28 014 008 Festo VTUG VABM-L1-14G-G14-8-GR				= Grundplatte leer 8 Plätze
80 28 014 010 Festo VTUG VABM-L1-14G-G14-10-GR				= Grundplatte leer 10 Plätze
80 28 014 012 Festo VTUG VABM-L1-14G-G14-12-GR				= Grundplatte leer 12 Plätze

### Übersicht Ventilblöcke

Aggr. BBE